



— 2018 —

DOORS

ENTRY | PATIO | STORM

WHAT MAKES PROVIA® PROFESSIONAL-CLASS?



TAILORED JUST FOR YOUR HOME

Nothing feels quite as good as well-tailored clothing, created specifically to your size, shape and style preference. Off-the-rack clothing just doesn't fit everyone's measurements. Similarly, off-the-rack doors fall short of expectations in the same way. The materials and workmanship that goes into custom-made doors are of exceptional quality and durability, and far exceeds what is available as ready-made. Unlike consumer-grade doors, which are cut down to fit your need, professional-class doors are built to your exact measurements for a better fit and a more secure and energy efficient door.

Entry systems tailored for you - that's **THE PROFESSIONAL WAY.**



HIGHEST STANDARDS

ProVia is committed to making doors individually customized for homeowners to the highest standards of durability, security and energy efficiency in the residential market. A clear difference so defining that it has established a new category of professional-class doors, a better alternative to consumer-grade doors.

SECURITY

We focus on the strength and security of every door so you can focus on what's really important - your life.

DURABILITY

Made with the finest materials and backed by our Lifetime Limited Transferable Warranty, our durability can't be beat.

BEAUTY

A beautiful ProVia entry system will always greet your guests with classic elegance and style.

ENERGY EFFICIENCY

Engineered to keep the elements at bay and your home comfortable all year long.





**PROVIA BUILDS DOORS
THE PROFESSIONAL WAY**

ProVia has developed a competitive position by catering to a niche within the door market that demands a high degree of customization coupled with outstanding quality. Our company defines the products that meet this demand as “professional-class.” We have found success by adhering to a set of core values that guide us as we develop rewarding, long-term relationships with our employees, customers and homeowners.

— WE SERVE, BY CARING FOR —
DETAILS
IN WAYS OTHERS WON'T

IT HAS LED US TO
EXACTING STANDARDS

If you ask around, you'll find attention to detail is what our customers have come to appreciate and expect from the ProVia brand. Our company is family-owned and faith-based with an intense focus on producing Professional-Class products. ProVia feels so strongly about the performance and workmanship of our entry system—built by skilled craftspeople with state-of-the-art manufacturing processes—that it's backed with a Lifetime Limited Warranty. The warranty is even transferable to one subsequent owner. You can visit our website provia.com for details. We're building your doors and our company to last a lifetime - that's **THE PROFESSIONAL WAY.**

ENTRY DOORS

DOOR CONSTRUCTION

- Features & Benefits 10
- Embarq® Fiberglass Features..... 14
- Signet® Fiberglass Features 18
- Heritage™ Fiberglass Features 20
- Legacy™ Steel Features 22

GLASS

ComforTech™ Glazing Systems

- ComforTech Benefits 24

Decorative Glass

- Essence 28
- Cheyenne..... 30
- Brilliance 32
- Symphony 34
- Berkley 36
- Laurence 38
- Carrington..... 40
- Tacoma..... 42
- Somerset..... 44
- Carmen 46
- Barcelona..... 48
- Lynford 50
- Constance 52
- Tranquility 54
- Gemstone 56
- Jewel 58
- Eclipse 60
- Florence 62
- Esmond..... 64
- Carlisle 66
- Beveled..... 68
- Tuscany..... 70
- Twilight..... 72

Inspirations™ Art Glass..... 74

Privacy Glass

- Chinchilla 76
- Taffeta..... 76
- Waterfall..... 76
- Gluechip..... 76
- Obscure Pebble 76

Clear Glass

- Internal Blinds..... 78
- Simulated Divided Lites 80
- Internal Grids..... 82
- External Grids..... 84
- Clear Glass..... 86

Doors Without Glass 88

FINISHING TOUCHES

- Inscribed Doors..... 90
- Glazed Finishes 92
- Embarq & Signet Fiberglass Finishes... 94
- Heritage Fiberglass Finishes..... 96
- Legacy Steel Finishes 98
- Hardware..... 100
- Speakeasy, Hinge Straps, Clavos... 116
- Freedom Pet Doors 118
- Casing 118
- Cladding 119

8' Doors..... 120

French Doors..... 122

PATIO DOORS

- Designer™ Hinged Patio Doors 124
- Vinyl Sliding Patio Doors 126

STORM DOORS

- Features and Benefits 130
- Spectrum™ 134
- Decorator™ 136
- Deluxe™ 138
- DuraGuard™ 140
- Superview™ 142
- Hardware..... 144
- Accessories 148

IMPACT SHIELD PRODUCTS

- About Impact Shield Products..... 150
- Available Styles..... 152

Door Construction

Glass

Finishing Touches

Patio Doors

Storm Doors

Impact Shield

ENVIRONMENTAL STEWARDSHIP

A young child with dark hair, wearing a bright green t-shirt and blue sleeves, is holding a small tree sapling with both hands. The child is looking down at the tree with a gentle expression. The background is a soft-focus green field.

Your education. . .
...is our
future

ENERGY STAR®

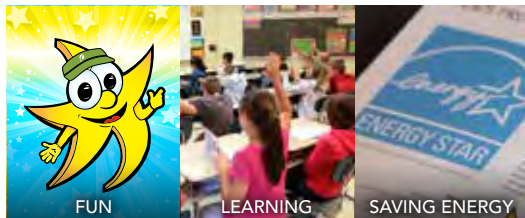

ProVia's ENERGY STAR certified doors and windows are independently tested and certified to meet strict energy-efficiency standards set by the Environmental Protection Agency (EPA). The EPA has awarded ProVia® ten times, four for Partner of the Year, four for Partner of the Year – Sustained Excellence, and once for Excellence in Promotion. Most recently, ProVia was awarded ENERGY STAR Partner of the Year - Sustained Excellence for Door and Window Manufacturing.



Most of our Entry Systems are ENERGY STAR certified.

At ProVia, not only do we manufacture energy efficient products, but we also exercise corporate environmental stewardship. Here are a few examples:

- We recycle paper, metals and glass.
- Solar energy panels are being used at three production facilities as part of the company's effort to lower energy costs.
- Our Pollution Prevention Program dramatically reduced solvent usage.
- To save fuel, our trucks use the TriPac™ Idle Reduction and Temperature Management System.
- Paperless online ordering and internal paperless fax system reduces paper usage.

For more information, visit the Environmental Stewardship section of our website at: provia.com/energy-star

STANDING UP TO THE ELEMENTS



CERTIFIED WIND LOAD PRODUCTS

Most products in this catalog meet or exceed testing standards required by the Florida Building Code. Products that were NOT tested for Certified Wind Load regions are noted throughout this catalog in **gold colored type**.



IMPACT SHIELD
PRODUCTS

Impact Shield Products are designed to protect your family and home against the harshest storms and help deter burglaries. Impact Shield products feature laminated glass and can withstand repeated blows from wind-borne debris or unwanted intruders and are indicated throughout this catalog with the blue shield icon and **blue colored type**. See Impact Shield section on pgs 150-167 for information and available styles.

We're constantly testing new Certified Wind Load and Impact Shield products.

For the latest information visit: provia.com/certification

How does **YOUR HOME'S STYLE** determine **YOUR CHOICE** of a new entryway?

Your home has its own style and every component works in harmony to create that style. Choosing a door and door glass that fits your needs, as well as your style, is important. We make it easy for you to make the choice that's right for you. When you combine your preferred door style, door glass, paint or stain finish, plus hardware and accessories, the end result is a customized entryway that reflects your personalized style.

Photographs have been provided to offer ideas on how ProVia® doors can be incorporated onto a variety of home styles. We understand your personal style will be a major factor in determining which door and glass is right for you, so please browse through the entire catalog to find a style that best fits your needs.

SUGGESTIONS TO GET YOU STARTED

AMERICAN CRAFTSMAN STYLE

Might include: Craftsman, Arts and Crafts, Cottage, Bungalows and Prairie House.



Suggested Door Styles:



420-DS

420

430

419

006

Suggested Glass Styles:

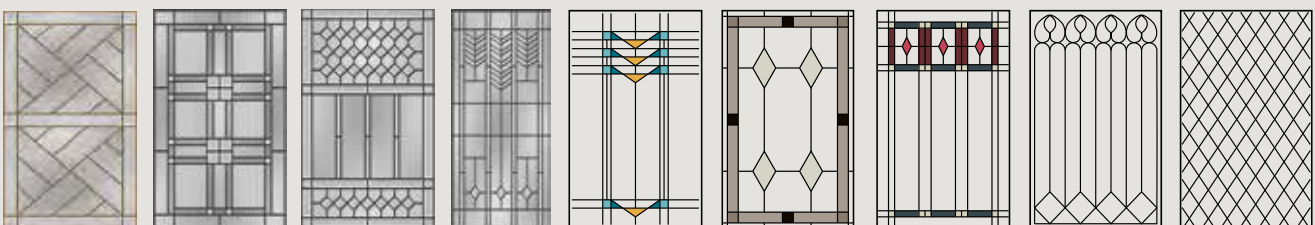

Berkley

Laurence

Carrington

Tacoma

Aztec

Vintage

Lincoln

Cambria

Westin

CLASSIC/COLONIAL STYLE

Might include: Federal, Cape Cod, Dutch, Farmhouse, Traditional, Georgian and Gambrel.



Suggested Door Styles:



460

430

440

150

230

006

400

419

Suggested Glass Styles:



Brilliance

Symphony

Somerset

Lynford

Constance

Jewel

Eclipse

Florence



Beveled



Tuscany



Twilight

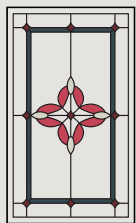

Haven

OLD WORLD STYLE

Might Include: Victorian, Queen Anne, Neo-eclectic, Mediterranean, European and French Countryside.



Suggested Door Styles:



449 460 350 437 439 243 008P 002C-449 002CP-437 003

Suggested Glass Styles:

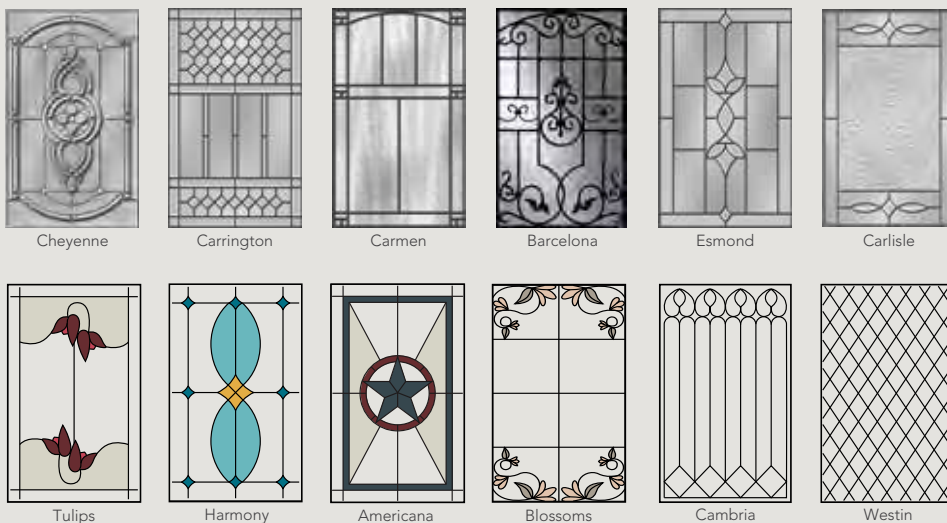

Cheyenne Carrington Carmen Barcelona Esmond Carlisle
 Tulips Harmony Americana Blossoms Cambria Westin

MODERN/CONTEMPORARY STYLE

Might include: Ranch, Split Level, International, Rectangular, Geometric and Curved Architecture.



Suggested Door Styles:



Suggested Glass Styles:

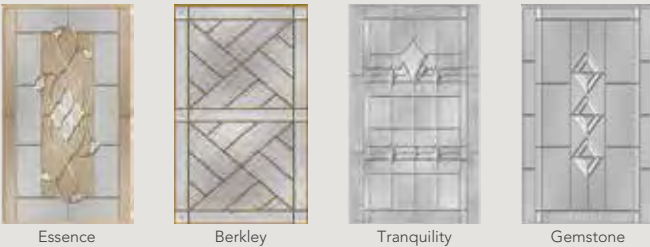

VISUALIZE

WITH PROVIA'S EXTERIOR **HOME DESIGN TOOL** FOR iPad

Use this powerful visualization engine to configure doors and windows or select from ProVia's impressive collection of vinyl siding and manufactured stone styles. Or, view brochures, videos and photo galleries.



AN iPad APP CHOCK **FULL OF FUNCTIONALITY!**

- Snap a picture of your home or use a stock photo
- Play with various combinations of doors, windows, siding and stone
- Discover the products that are perfect for your home

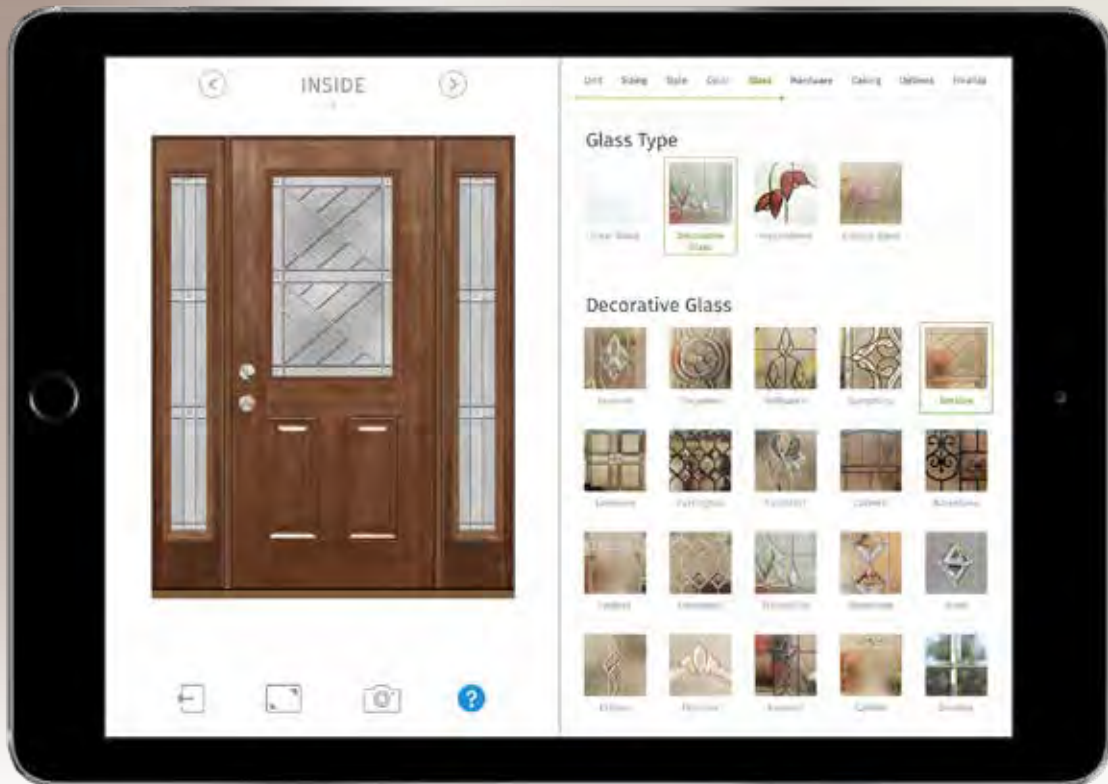

DESIGN YOUR DREAM ENTRYWAY

This exclusive app contains our full line of door types and styles, decorative glass, Inspirations™ Art Glass, grids, clear glass, hardware and options and much more!

Visit the App Store to download your free app today!



THE COMPONENTS

The components are the small things that set our doors apart from the competition. A lot of small things add up to a big difference.





A

Our **stains and glazed finishes** are hand-applied by **professionals**, then oven-cured for maximum beauty and durability. **State-of-the-art electrostatic paint application** ensures a beautiful even coat.



SHERWIN WILLIAMS

You can have your **Entry System painted or stained in any custom color.** (Additional lead-time required. Custom stains only available on Signet Fiberglass doors.)



B

We offer **hardware from Trilennium®, Hoppe®, Emtex®, Brinks® and Schlage®** that provide some of the most stylish, durable hardware available today.



C

Our **polyurethane core** reduces energy loss.

FRAME OPTIONS



NEW
FrameSaver®
POWERED BY ENDURA

Real World Frame Issues



Shrinking and swelling occur from changes in relative humidity in the atmosphere. **Water wicks** up through wood fibers resulting in **paint peeling, rot and mold.** Traditional door frames begin to rot within 3-6 months of field installation.

FrameSaver® Advantages



Our **finger-jointed composite bottom** never absorbs water, warps, cracks or rots, and paints and finishes just like wood. Plus, FrameSaver is backed by the industry's only **fully-transferable lifetime limited warranty** for ultimate peace of mind.

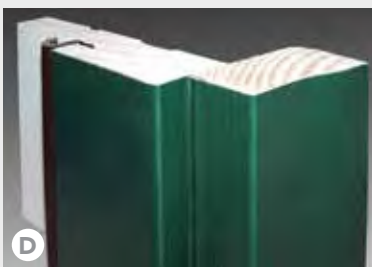

D

New FrameSaver™ wood frame and brickmold with finger-jointed composite bottom prevents water absorption and carries a Lifetime Limited Warranty when used with **PVC vinyl coated aluminum frame cladding** outside. **Also available with smooth cladding.** See pg. 119.

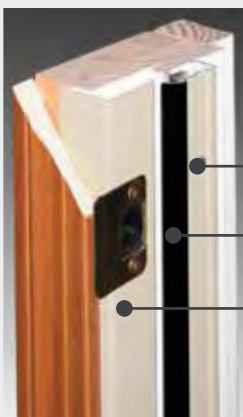

Steel L-Frame

Available on select Signet and Legacy door styles

- Aluminum door stop provides greater security and is more durable than wood.
- Energy efficient weatherstripping.
- 18-gauge steel L-frame with a 12-gauge hinge plate welded on for extra strength and security.

(NOT tested for Certified Wind Load or Impact Shield regions)

Not all Steel L-Frames are ENERGY STAR® certified. Visit ProVia®'s website for manufacturer's certification statement.



Our **PermaTech™ Composite door frame system** option combines all the strength and convenience of wood with enhanced properties that make it moisture and insect resistant. PermaTech will not absorb or wick moisture and will never rot or splinter, and is covered by a Lifetime Limited Warranty.*

* No storm door applied. See full warranty for limitations
† See price list for available styles.

THE COMPONENTS

(CONTINUED)



440TAC-2P, 140TAC

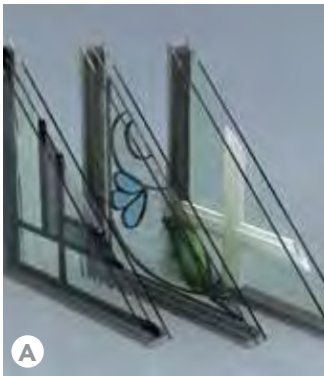

Your home is unique and deserves to have **custom glass options** like our Comfortech™ Warm Edge Glazing Systems which include decorative glass, Inspirations™ art glass, internal blinds and internal and external grids in many grid patterns and colors.

 Impact Shield doors feature laminated glass.



Our **2½" casing** conveniently covers paint lines providing a professional installation. **Also available in 3½"**. Choose from Cherry, Mahogany, Oak and Poplar. **New Flat Fir and Poplar trim are available in paint, stain and glazed finishes.**



Three **heavy-duty ball bearing hinges** come standard with every entry system.

Additional 4th hinge option for greater durability. (only available with Full Wood Frame)

 Impact Shield doors have heavy-duty stainless steel hinges.



The energy efficient **weatherstripping** runs along the top and sides of the door and interlocks with the **CornerShield™** for the most efficient seal you'll find for keeping moisture, wind and dirt out of your home.

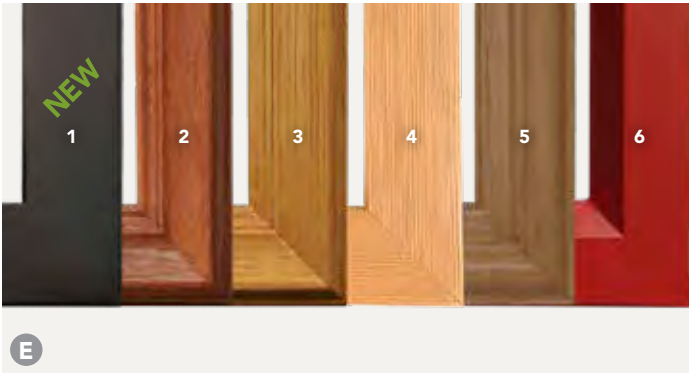

High-performance, heat-resistant window trim is warranted not to warp, crack or pull away from the door, even in sunny or higher temperature applications. **Plugless window trim** (Patent Pending) is standard on Embarq® and Signet® (N/A on Fir Series) and optional for Heritage™† and Legacy™†.

1. Smooth (standard on select Signet Smooth doors and sidelites, optional on select Heritage Smooth and Legacy Smooth doors and sidelites) **2.** Embarq and Signet Cherry and Mahogany **3.** Embarq and Signet Oak and Knotty Alder **4.** Signet Fir **5.** Heritage and Legacy **6.** Modern Flat Trim (only available on models 112, 114, 115, 116 and 160 sidelites)

 Impact Shield doors have aluminum window trim.

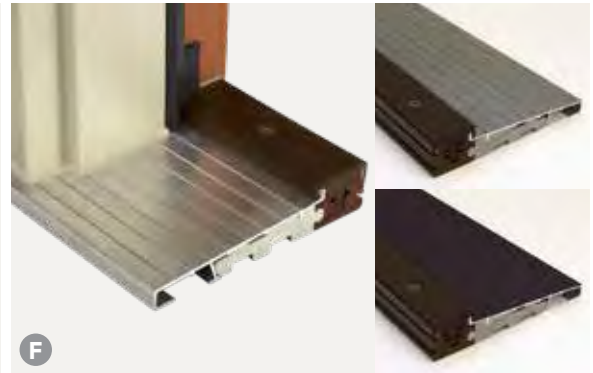

Our exclusive **Sahara™ heavy-duty extruded threshold** has a wide thermal barrier wood-look riser that will not warp or rot while providing excellent energy efficiency. On entry systems with sidelites, our continuous threshold improves structural integrity and helps prevent rotting. Available in Mill finish, Anodized Nickel or Anodized Bronze finishes.

 Thresholds for Impact Shield rated Heritage Fiberglass and Hinged Patio Doors have an oak-like riser and do not have composite base material



We include our **20-gauge security plate** for extra strength and to help prevent kick-ins.

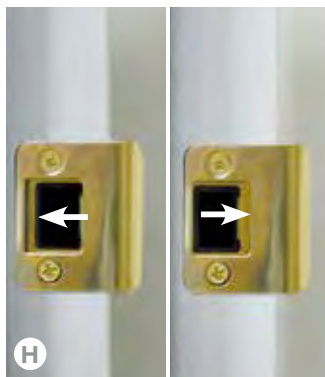

We include a **solid brass fully adjustable strike plate** of our own exclusive design. This unique 2-piece construction makes our doors easier to custom fit.

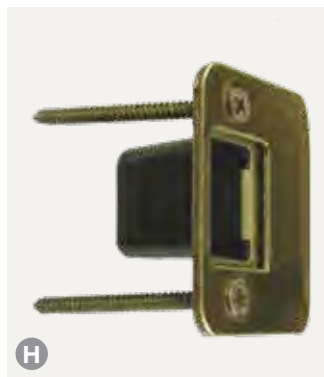

The **dust box** in the deadbolt strike provides a barrier to air infiltration while providing a nice appearance that most other door manufacturers don't provide.

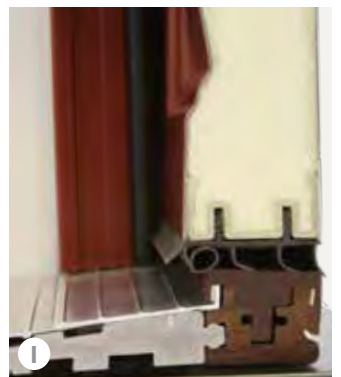

Bulb and blade sweep virtually eliminates drafts, keeping your home comfortable.

EMBARQ® FIBERGLASS



ProVia® Earns Crystal Achievement Award for **Most Innovative Door** from *Window & Door Magazine*

Crystal Achievement Awards recognize significant innovations and achievements in window and door technology, manufacturing and marketing.

"Every aspect of the ProVia [Embarq] fiberglass door makes it a winner."

- Crystal Achievement Award Judge

EMBARQ SERIES



A NEW WAY OF THINKING

We set out on a journey to develop a new door and it expanded into a complete philosophy of creating unrivaled efficiency in home building products. We call this new way of thinking "EnVision," and are proud to introduce its first creation: **Embarq** – the doorway to innovation and efficiency.

10-YEAR FINISH WARRANTY*

See pgs. 94-95 for paint and stain finishes



ALL Embarq Fiberglass Entry Systems are ENERGY STAR® Certified.

EMBARQ FIBERGLASS DOOR STYLES

See pages 34-93 for glass availability.

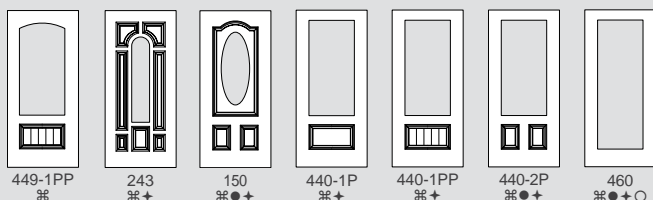

SIDELITES

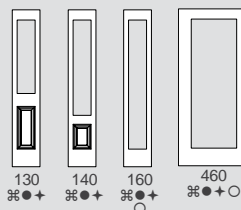

- ⌘ Signet® Cherry Series
- Signet® Mahogany Series
- + Signet® Oak Series
- Signet® Knotty Alder Series

* Warranty time period may be limited in extreme applications. See warranty for details.

Stiles and rails are dovetailed and glued at each corner creating a structurally solid, integrated frame.



To enhance efficiency and accommodate more insulation, we thickened the door and sidelites from the standard 1 3/4" to 2 1/2" which is **43% thicker** than standard exterior doors. We also engineered a **dual perimeter seal** for the entry door to create a superior barrier against drafts and energy leaks.



We engineered a channel in the side rails and header of the door to allow for a **larger energy efficient polyurethane core**. Our computer-controlled process fills every crevice with the foam barrier material resulting in **a level of energy efficiency unparalleled in the industry**.

We started from the inside out to maximize energy savings and reduce thermal loss, resulting in the most energy efficient door in the U.S. market. In fact, this door offers at least **4-times more insulating value than a typical wood door** giving an unprecedented U-Factor of 0.09 - the lowest recorded heat conduction measurement for entry doors in the U.S.

Door edge is constructed with cherry, mahogany or oak wood matching the selected series.

The **4 1/4" finger-jointed 4-ply hardwood strike stile** provides a solid mounting surface for Emttek® hardware and superior structural integrity.

The **authentic wood look** is made possible by using cutting-edge **NVD** (Nickel Vapor Deposition) technology by MasterGrain™.

Scientifically formulated compounds provide superior resistance to denting, splitting, cracking and warping.

The revolutionary **DuraFuse™ Finishing System featuring P³ Fusion** yields unprecedented finish durability.

Our exclusive **Bronze Sahara™ heavy-duty extruded threshold** has a **2 3/8" wide thermal barrier** wood-look riser that will not warp or rot while providing excellent energy efficiency. Also available in Anodized Nickel or Mill finish.

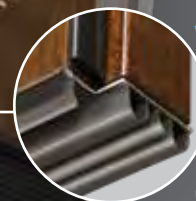
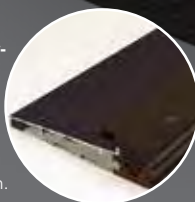

We **custom designed a sweep** to accommodate the Embarq door's added thickness. This creates a new breed of thermal barrier to keep out unwanted elements and uncomfortable temperatures.

QUAD GLASS SYSTEM

Our EnVision™ innovation and technology has created a revolutionary new design utilizing a Quad Glass System. This glass system is only available for Embarq fiberglass doors and sidelites and utilizes the most energy efficient glass package available on the market today. This high performance glass system provides an optimal energy efficiency rating.

- A** Low-E Glass Surface
- B** Krypton Filled Air Space
- C** Decorative Glass Core
- D** Super Spacer®
- E** Tri-Seal Spacer
- F** We re-engineered our ComforTech™ Warm Edge Glazing System to accommodate for the extra panes of glass in this highly efficient package.



QLK 1¹³/₁₆"
Insulated Glass Unit

EMBARQ GLASS PACKAGES

ComforTech™ **QLK**
(Krypton Gas Filled)

R-Value of 10

ComforTech™ **QLA**
(Argon Gas Filled)

R-Value of 9

R-Value reflects properties of the glass only.
Embarq glass package center of glass calculations.

SERIES AND FINISHES

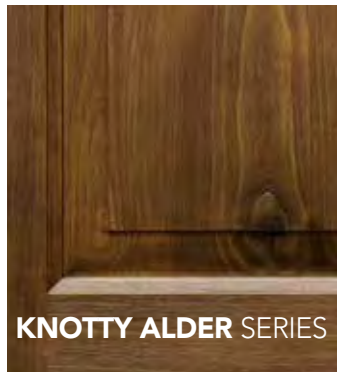
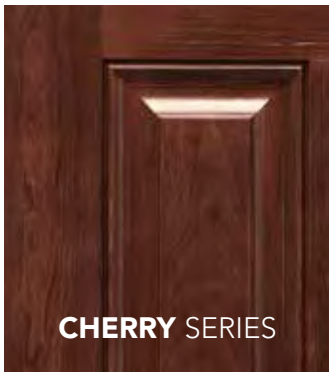
Embarq doors available in Cherry, Mahogany, Oak and Knotty Alder Series and feature all the same stain and paint finishes as our Signet® doors shown on pg. 95.



HARDWARE

Embarq doors are only available with Emtek® hardware. See pg. 106 for finish availability.

EXTERIOR STYLES



Melrose Imperial Ribbon & Reed Orleans Marietta

INTERIOR STYLES (Any interior handle can be used with any exterior handle)



Egg (Shown on Melrose) Egg (Shown on Marietta) Cortina (Shown on Orleans) Turino (Shown on Imperial and Ribbon & Reed)

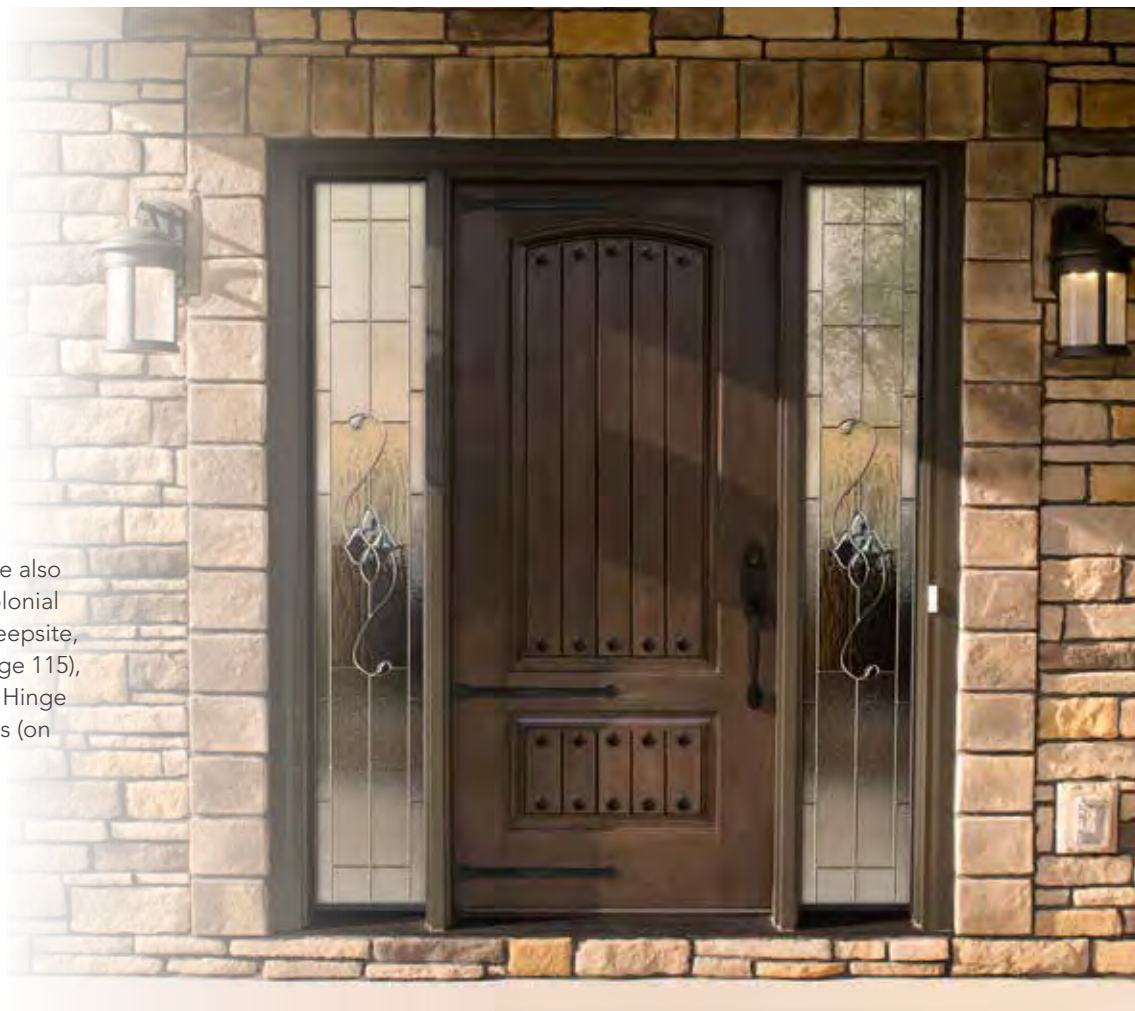

Embarq doors are also available with Colonial Door Knocker, Peepsite, Kick Plate (on page 115), Faux Speakeasy, Hinge Straps and Clavos (on page 117).

SIGNET® FIBERGLASS

SIGNET SERIES



Signet Fiberglass doors are available in Cherry, Mahogany, Oak, Fir, Knotty Alder and Smooth Series. Structurally, the Signet door is far superior to traditional fiberglass doors with robust hardwood stiles and rails dovetailed at each corner. All Signet Fiberglass doors exhibit our exclusive DuraFuse™ Finishing System featuring P³ Fusion, allowing us to offer an industry-best 10-year* finish warranty.



Most Signet Fiberglass Entry Systems are ENERGY STAR® Certified.

10-YEAR FINISH WARRANTY*
See pgs. 94-95 for paint and stain finishes



CUSTOMIZE BOTH SIDES

You can customize your entry by ordering a different series, style and finish on each side of your door.



CUSTOM WIDTHS & HEIGHTS

Need a little more height or a little less width? We offer customized door and sidelite widths and heights in 1/8" increments.

SIGNET FIBERGLASS DOOR STYLES See pages 34-93 for glass availability.

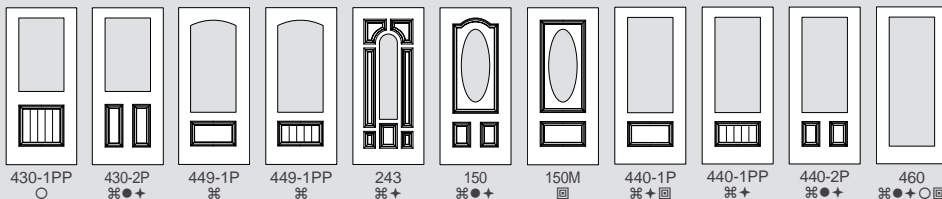
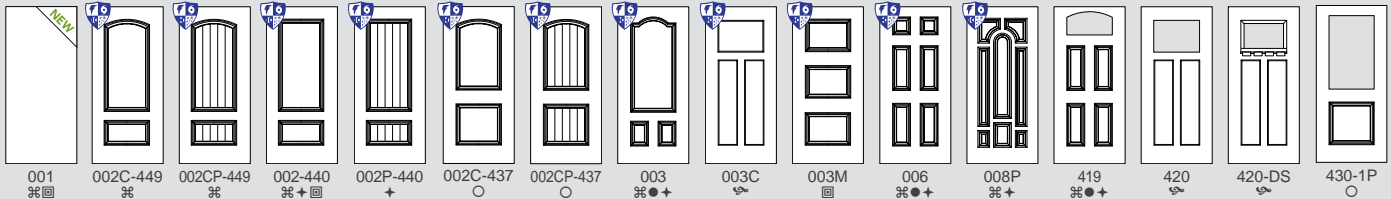

SIDELITES

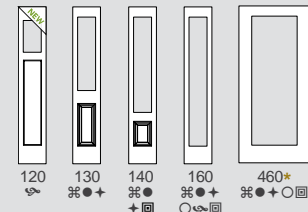

8' DOORS

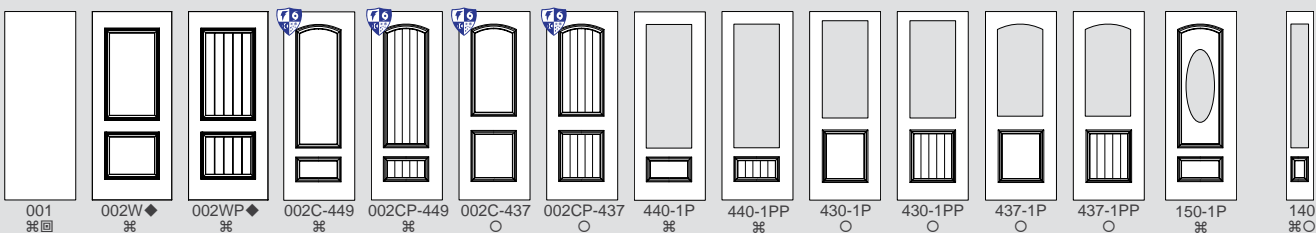

8' SIDELITE

- ⌘ Signet Cherry Series
- Signet Mahogany Series
- Signet Oak Series
- ⊕ Signet Knotty Alder Series
- ⌘ Signet Fir Series
- ⊞ Signet Smooth Series

◆ Only available in 42" x 96" size

Signet Fiberglass doors without glass are available as an Impact Shield Product.

* NOT tested for Certified Wind Load regions

Entry System U-Factor: As low as .16 (Tested to NFRC specifications for a 6 panel door with wood frame).
Note: All Signet doors are shipped finished.

* Warranty time period may be limited in extreme applications. See warranty for details.
† Patents - USD617005, USD621062, USD621063, USD625837, USD625024

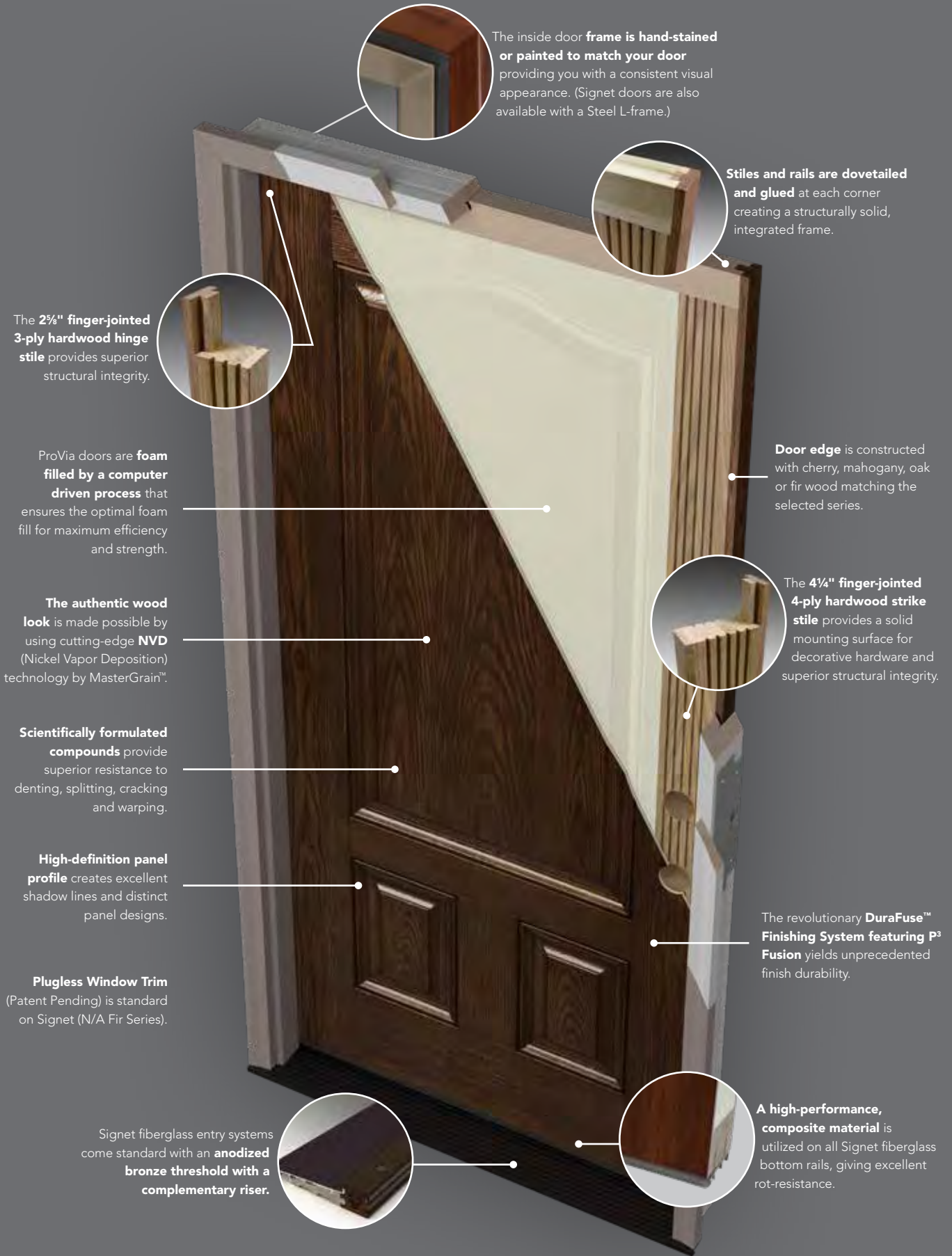

The inside door **frame is hand-stained or painted to match your door** providing you with a consistent visual appearance. (Signet doors are also available with a Steel L-frame.)

Stiles and rails are dovetailed and glued at each corner creating a structurally solid, integrated frame.

The **2½" finger-jointed 3-ply hardwood hinge stile** provides superior structural integrity.

ProVia doors are **foam filled by a computer driven process** that ensures the optimal foam fill for maximum efficiency and strength.

Door edge is constructed with cherry, mahogany, oak or fir wood matching the selected series.

The **authentic wood look** is made possible by using cutting-edge **NVD** (Nickel Vapor Deposition) technology by MasterGrain™.

The **4¼" finger-jointed 4-ply hardwood strike stile** provides a solid mounting surface for decorative hardware and superior structural integrity.

Scientifically formulated compounds provide superior resistance to denting, splitting, cracking and warping.

High-definition panel profile creates excellent shadow lines and distinct panel designs.

The revolutionary **DuraFuse™ Finishing System featuring P³ Fusion** yields unprecedented finish durability.

Plugless Window Trim (Patent Pending) is standard on Signet (N/A Fir Series).

Signet fiberglass entry systems come standard with an **anodized bronze threshold with a complementary riser.**

A **high-performance, composite material** is utilized on all Signet fiberglass bottom rails, giving excellent rot-resistance.

HERITAGE™ FIBERGLASS

HERITAGE SKIN OPTIONS

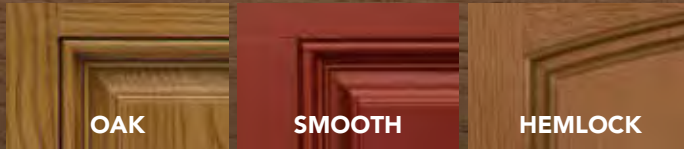

Heritage Fiberglass doors feature enhanced woodgrain texture, improved definition embossing and a hardwood edge to prevent warping.



Most Heritage Fiberglass Entry Systems are ENERGY STAR® Certified.

7-YEAR FINISH WARRANTY*

See pgs. 96-97 for paint and stain finishes



CUSTOM HEIGHTS

Need a little more or a little less height? We offer customized door and sidelite heights in 1/8" increments.

HERITAGE FIBERGLASS DOOR STYLES

See pages 34-93 for glass availability.

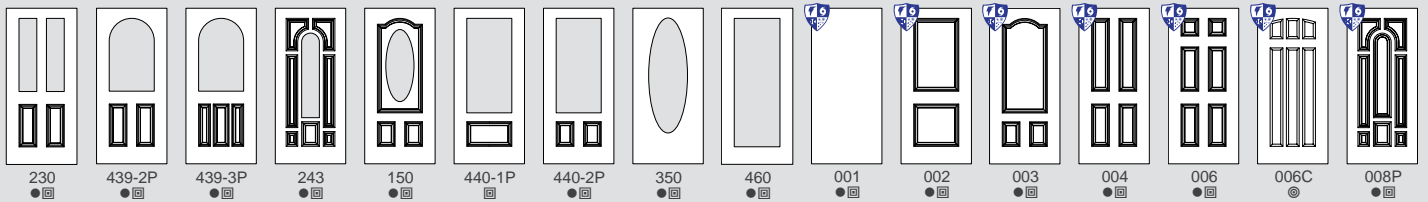
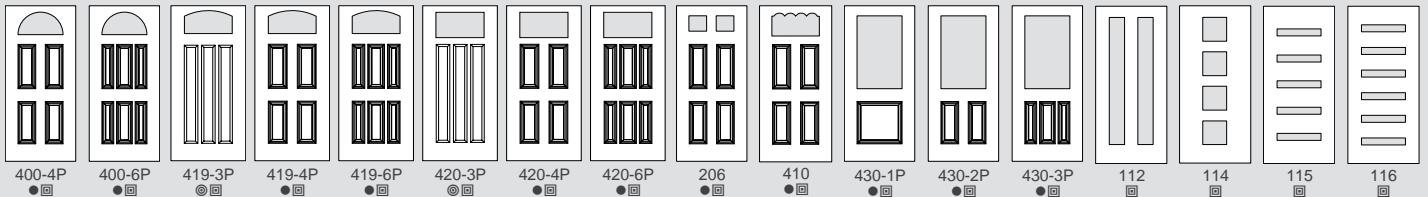

8' DOORS

SIDELITES

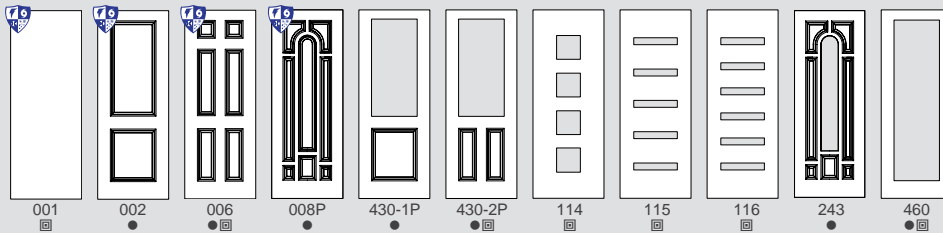
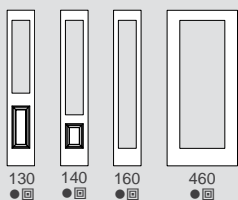

8' SIDELITES

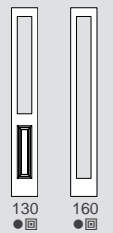

- Oak Grain Pattern
- ⊙ Hemlock Grain Pattern
- ▣ Smooth Fiberglass

All Heritage Fiberglass doors without glass are available as an Impact Shield Product.

Entry System U-Factor: As low as .14 (Tested to NFRC specifications for a 6 panel door with wood frame).

* Warranty time period may be limited in extreme applications. See warranty for details.



Polyurethane core reduces energy loss.

Improved definition panel profile creates excellent shadow lines and distinct panel designs.

Specially engineered fiberglass door facings will not dent and resist splitting, cracking and warping.

Plugless Window Trim is optional on Heritage Fiberglass (see Price List for available styles)

Heritage fiberglass entry systems come standard with an **anodized nickel threshold with a complementary riser.**



1 1/2" Finger-jointed, 2-ply solid oak laminated stiles for both hinge and strike sides are proven to provide increased rigidity and structural integrity.

Variable-depth woodgrain texture with hand-applied stain imitates a wood door appearance.

Square-edge design offers an attractive wood door appearance.

Lock area is reinforced to provide a solid mounting surface for decorative hardware.

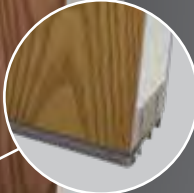

A high-performance, composite material is utilized on all Heritage fiberglass bottom rails, giving excellent rot-resistance.



LEGACY™ STEEL

LEGACY SKIN OPTIONS



Legacy Steel features add up to a professional-class product. Whether you select Legacy Woodgrain Textured Steel or Smooth Steel, our entry systems will provide an elegant, durable and energy efficient addition to any home.

7-YEAR FINISH WARRANTY*
See pgs. 98-99 for paint and stain finishes



Most Legacy Steel Entry Systems are ENERGY STAR® Certified.

Legacy Steel Doors with full-lite or half-lite decorative glass with ComforTech™ glazing will include a pane of Low-E glass in order to be ENERGY STAR certified. This includes the following styles; 150, 230, 239, 240, 350, 430, 437, 439 and 460. Since Low-E glass has a slight color tint, it is recommended that sidelites and transoms are ordered with optional Low-E pane to match the door.



CUSTOMIZE BOTH SIDES
You can customize your entry by ordering a different series, style and finish on each side of your door.



CUSTOM WIDTHS & HEIGHTS
Need a little more height or a little less width? We offer customized door and sidelite widths and heights in 1/8" increments.

LEGACY STEEL DOOR STYLES See pages 34-93 for glass availability.

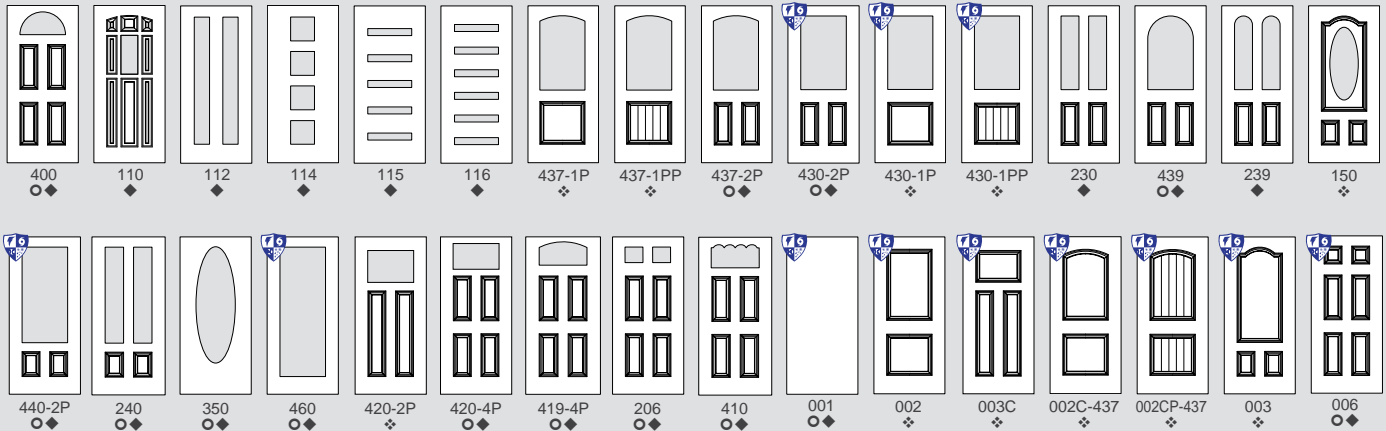

8' DOORS

8' SIDELITES

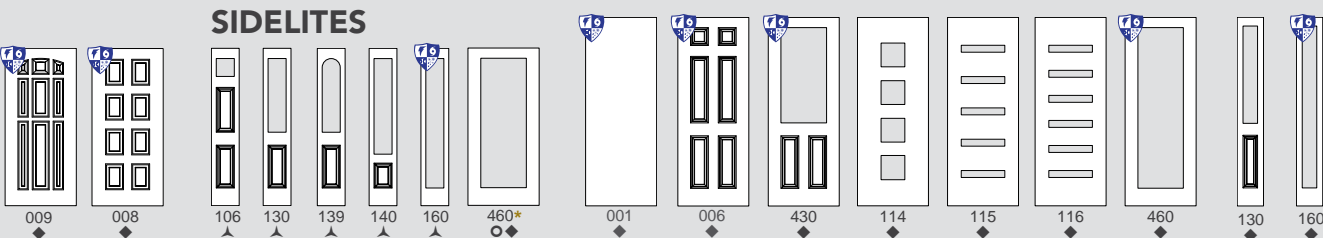

- 20-gauge Woodgrain Textured Steel
- ◆ 20-gauge Smooth Steel
- ❖ 20-gauge Smooth Steel with High-Definition Embossing
- ▲ 24-gauge Smooth or Textured Steel (used with all 20-gauge doors)

Indicated Legacy Steel doors are available as an Impact Shield Product.

* NOT tested for Certified Wind Load regions

Entry System U-Factor: As low as .17 (Tested to NFRC specifications for a 6 panel door with wood frame).

* Warranty time period may be limited in extreme applications. See warranty for details.

† Patent - USD621062



Composite top endcaps increase rigidity and energy efficiency.



Special adhesives/thermal barrier reduce heat and cold transfer, while our exclusive tab and slot system of **mechanical interlocks** gives the door exceptional structural strength.

ProVia doors are **foam filled by a computer driven process** that ensures the optimal foam fill for maximum energy efficiency and strength.

The edges and face skin of our steel doors are **one continuous piece of steel** for strength and durability.

To reinforce the lock and deadbolt area, we add a **rigid composite lock block** to all of our steel doors.

Plugless Window Trim is optional on Legacy Steel (see Price List for available styles)

Our 20-gauge steel doors give you **49% more galvanized steel** than a standard 24-gauge door.

Legacy steel entry systems come standard with an **anodized nickel threshold with a complementary riser.**



Composite bottom endcaps increase rigidity and energy efficiency.



COMFORTECH™

LIFETIME LIMITED WARRANTY
Includes Glass Breakage and Seal Failure

Measurably improve thermal performance with our ComforTech™ Warm Edge Glazing System. You'll enjoy better energy efficiency and a warmer glass edge.

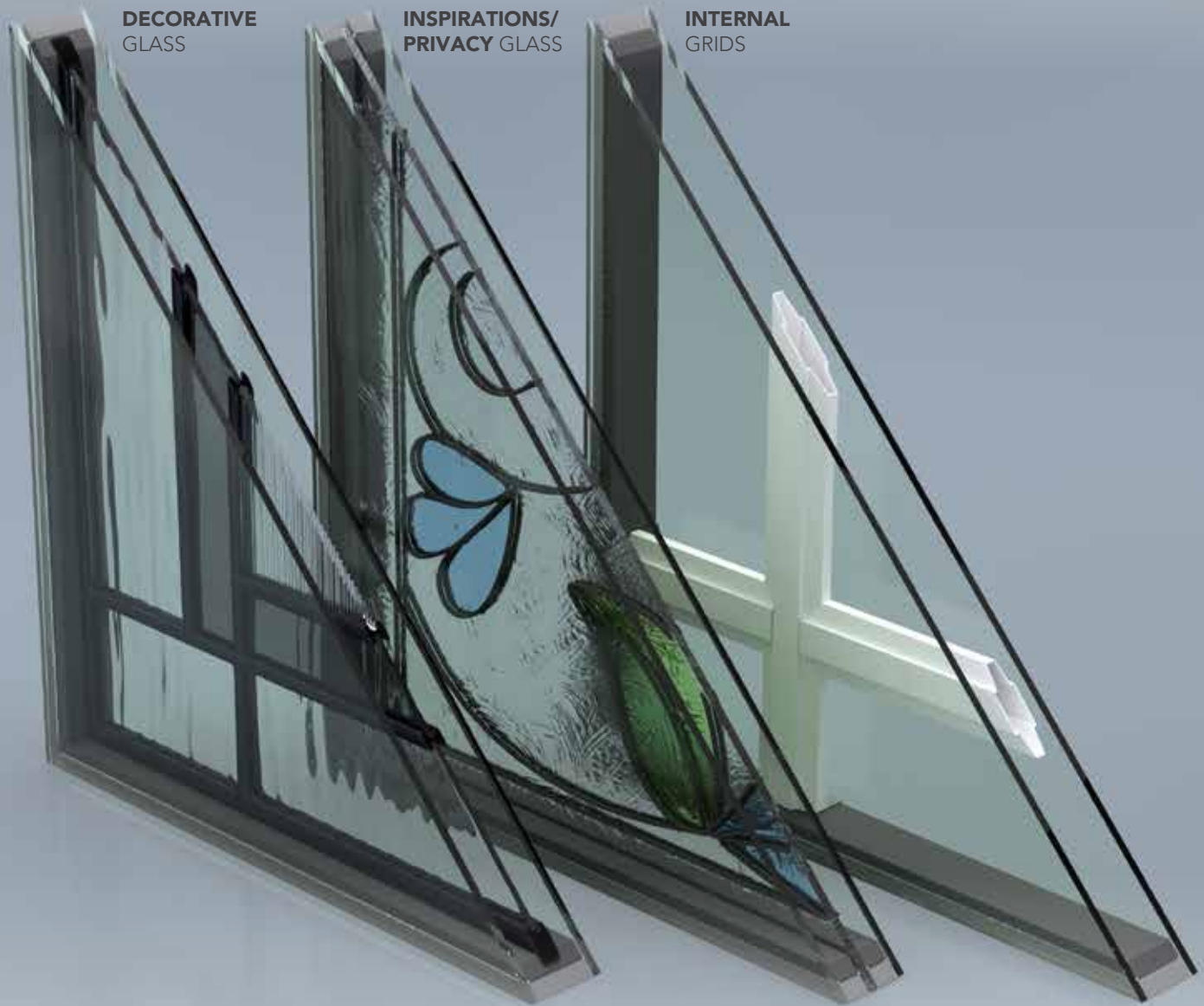

COMFORTECH™ WARM EDGE GLAZING SYSTEM IS INCLUDED IN ALL:

- Decorative Glass (except for Tuscany)
- Inspirations™ Art Glass
- Privacy Glass
- Clear Glass
- Grids (Internal, External and SDL)
- Designer™ Patio Doors
- Vinyl Sliding Patio Doors
- Vinyl Windows



COMFORTECH™ ADVANTAGES



The NO-Metal Advantage

"Thermal efficiency through no presence of conductive metals" is the Super Spacer® hallmark.



Mylar 10-Layer Vapor Barrier

The Super Spacer® thermoset foam matrix is exceptional. Moisture is kept out, gas is kept in and conductivity is virtually nonexistent.



Withstands Normal Bowing

The design of our Warm Edge Glazing System stands up to the bending and bowing that is natural in any glass unit.



Enhanced Noise Reduction

Our all-foam formula's excellent sound-dampening properties reduce outside noise, even in industrial environments.

GLAZING SYSTEM OPTIONS See page 142 for Impact Shield laminated glass options

ComforTech™ TLK ComforTech™ TLK-UV

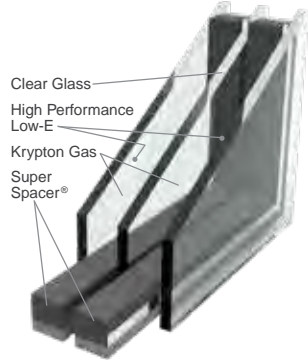

R-Value of 9

ComforTech™ TLA ComforTech™ TLA-UV

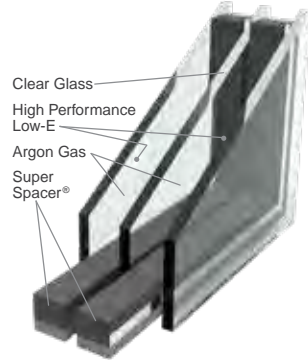

R-Value of 6

ComforTech™ DLA ComforTech™ DLA-UV

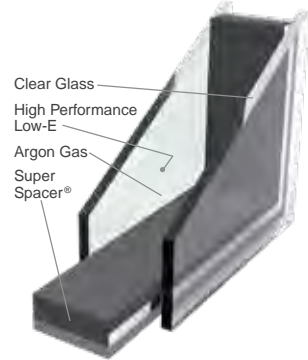

R-Value of 4

ComforTech™ DC



R-Value of 2

R-Value reflects properties of the glass only. Center of glass calculations are based upon software from Lawrence Berkeley National Laboratory.

NOW AVAILABLE:

ComforTech Elevation Series glass packages for products installed in high elevation areas. Additional information available in entryLINK, iPad App or Price List.



Entry Systems ComforTech™ Glass Package	R-Value	Solar Heat Gain Coefficient (SHGC)	Visible Light	UV Transmittance
INSULATED GLASS UNIT				
1" ComforTech DC	2	0.76	81%	59%
1" ComforTech DLA	4	0.40	72%	20%
1" ComforTech DLA-UV	4	0.27	64%	5.9%
1" ComforTech TLA	6	0.34	59%	6.9%
1" ComforTech TLA-UV	6	0.20	46%	0.7%
1" ComforTech TLK	9	0.34	59%	6.9%
1" ComforTech TLK-UV	9	0.20	46%	0.7%

DECORATIVE GLASS



Highly-skilled craftsmen assemble hand-beveled glass accented with a variety of unique glass options by precisely cutting, mitering and soldering each component into artistically designed patterns. Art glass purposefully seeks visual character through aesthetic imperfections, while maintaining structural stability. These "imperfections" mimic the hand-made sheet glass of centuries past. They come in the form of textural waves and striations, random seeds (air bubbles) and a variety of other natural effects. Art glass achieves its personality through these apparent

flaws and no two sheets are ever identical. Each glass panel is hand-made and reflects minor differences from piece to piece. This is characteristic of any hand-made product and adds to the charm and beauty of the product.

We continually inspect for consistency. The patterns can vary in size and particular shapes, but pose no danger of spontaneous breakage or structural instability. Any patterns that are severely out of character with the glass are not accepted. Our goal is to provide the finest quality glass panels.

ALL* DECORATIVE GLASS:

1. Is a ProVia Exclusive

These decorative glass designs are only found on ProVia doors. This gives your entryway a unique style that can't be found anywhere else.

2. Includes our ComforTech™ Warm Edge Glazing System

Measurably improve thermal performance with our ComforTech™ Warm Edge Glazing System. You'll enjoy better energy efficiency and a warmer glass edge.

3. Is Impact Shield available

Impact Shield Products are designed to protect your family and home against the harshest storms and help deter burglaries. Impact Shield products feature laminated glass and can withstand repeated blows from wind-borne debris or unwanted intruders. See pages 144-149 for style availability.

4. Is Covered by a Lifetime Limited Warranty

Warranty includes glass breakage and seal failure.

* Does NOT include Tuscany glass





Each piece of glass is meticulously inspected for consistency.



ESSENCE

DECORATIVE GLASS

Essence features a bronze seedy glass combined with micro-granite that brings elegance to a whole new level.

CAMING FINISH



Specify caming finish using these codes:
Brass - ESB, Zinc - ESZ

PRIVACY RATING



LIFETIME LIMITED WARRANTY
Includes Glass Breakage & Seal Failure



440ESB-1PP, 140ESB



All Full Wood Frame and Composite Frame Entry Systems using Essence Glass are ENERGY STAR® Certified and some Steel L-Frame Entry Systems using Essence Glass are ENERGY STAR Certified. See the ENERGY STAR section of our website for energy ratings on specific styles.

612/613ESZ** † pg. 102



160ESZ 460ESZ 160ESZ



140ESZ 440ESZ† 140ESZ



770ESZ † § 150ESZ† 770ESZ † §



240ESZ



130ESZ 430ESZ†



230ESZ



440ESZ† 140ESZ 430ESZ† 130ESZ 150ESZ

Essence Glass

ESSENCE STYLE AVAILABILITY

	Doors						Sidelites				8' Doors			8' Sidelites	
	460	440	150	240	430	230	160	140	770	130	440	430	150	140	130
Embarq / Signet Mahogany Series	•	•	•		•		•	•	•	•					
Embarq / Signet Cherry Series	•	•	•		•		•	•	•	•	*		*		*
Embarq / Signet Oak Series	•	•	•		•		•	•	•	•					
Embarq / Signet Knotty Alder Series	•				•		•		•			*			*
Signet Smooth Series	•	•	•				•	•	•						
Heritage Woodgrain Textured Fiberglass	•	•	•		•	•	•	•	•	•		•			•
Heritage Smooth Fiberglass	•	•	•		•	•	•	•	•	•		•			•
20-Gauge Woodgrain Textured Steel	•	•		•	•		○	○	•	○					
20-Gauge Smooth Steel	•	•	•	•	•	•	○	○	•	○		•			•
Price List Page Number	44	35	51	39	18	23	67	65	75	62	83	76	81	90	88
Price List Page Number (for Embarq)	138	135	140		131	24	144	143	147	142					

† For additional door panel styles see pg. 14 (for Embarq®), pg. 18 (for Signet®), pg. 20 (for Heritage™) or pg. 22 (for Legacy™)

§ Also available in 10" width (which requires an additional 4-week lead time). See Price List for design pattern

** Requires an additional 4-week lead time

○ Steel sidelites are made from 24-Gauge steel

* Embarq doors and sidelites are not available in 8' heights

⚠ Cannot be mulled with Heritage Fiberglass doors in Certified Wind Load regions

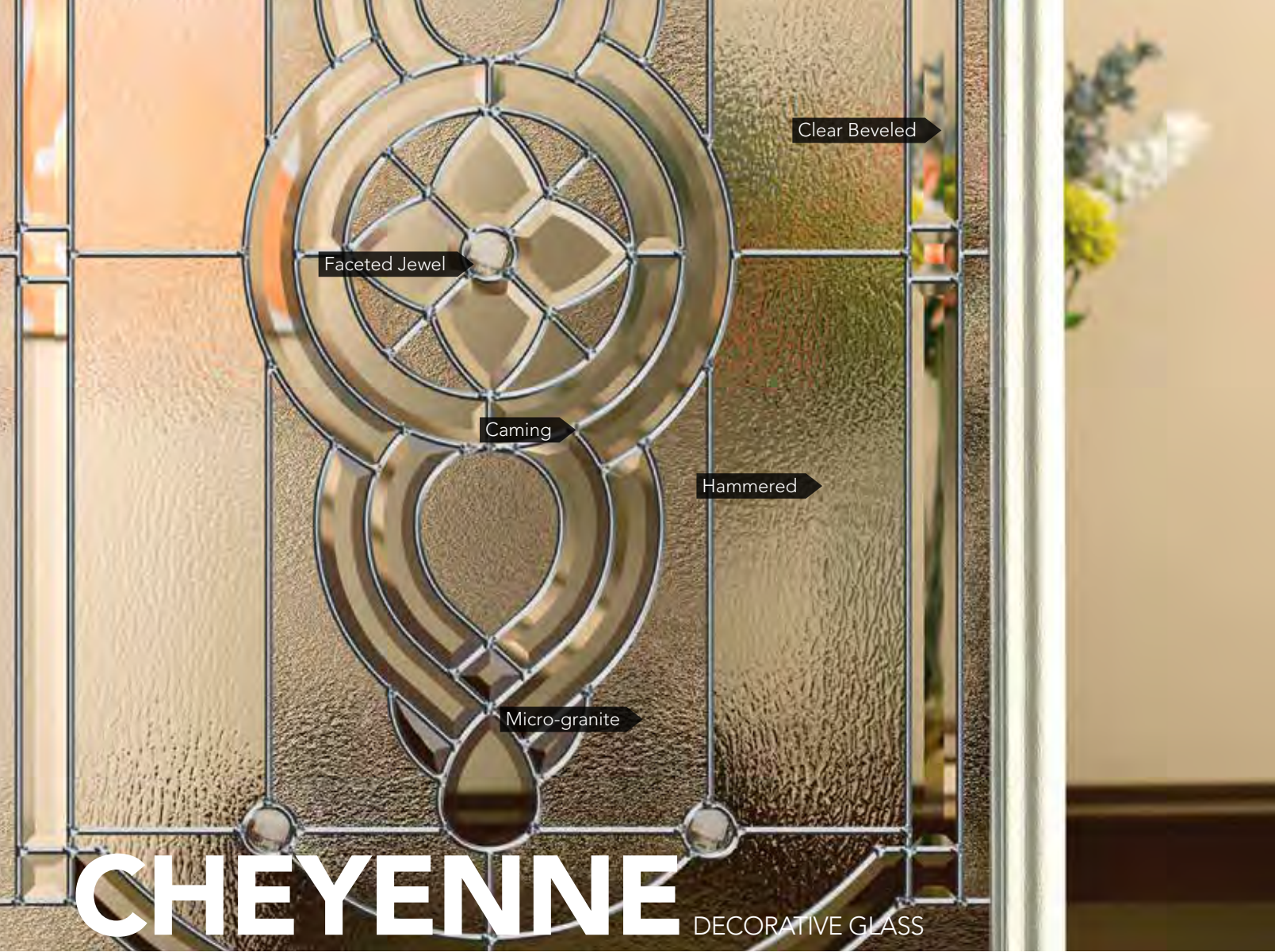

CHEYENNE

DECORATIVE GLASS

Cheyenne features micro-granite, hammered and beveled glass that will add elegance to your entryway, while providing a high level of privacy.

CAMING FINISH

Patina

Zinc

Specify caming finish using these codes:
Patina - CHP, Zinc - CHZ

PRIVACY RATING

1 2 3 4 5 6 7 **8** 9 10

less privacy more privacy

LIFETIME LIMITED WARRANTY
Includes Glass Breakage & Seal Failure



460CHP



All Full Wood Frame and Composite Frame Entry Systems using Cheyenne Glass are ENERGY STAR® Certified and some Steel L-Frame Entry Systems using Cheyenne Glass are ENERGY STAR Certified. See the ENERGY STAR section of our website for energy ratings on specific styles.

512/513CHP † pg. 100

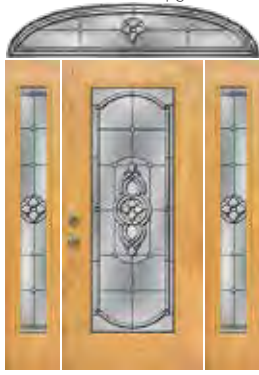

160CHP



460CHP

160CHP

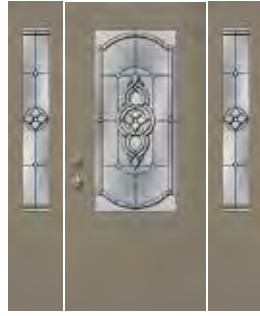

140CHP

440CHP †

140CHP



350CHP



150CHP †



240CHP



243CHP

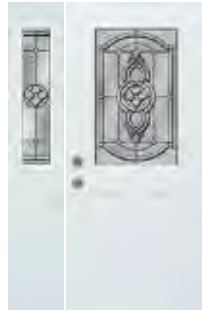

130CHP



430CHP †



230CHP



419CHP †



400CHP †



110CHP



8' DOORS

440CHP †

140CHP

430CHZ †

130CHZ

150CHZ

CHEYENNE STYLE AVAILABILITY

	Doors											Sidelites			8' Doors			8' Sidelites		
	460	440	350	150	240	243	430	230	419	400	110	160	140	130	440	430	150	140	130	
Embarq / Signet Mahogany Series	•	•		•			•		•			•	•	•						
Embarq / Signet Cherry Series	•	•		•		•	•		•			•	•	•	*		*		*	
Embarq / Signet Oak Series	•	•		•		•	•		•			•	•	•						
Embarq / Signet Knotty Alder Series	•						•					•					*		*	
Signet Smooth Series	•	•		•								•	•							
Heritage Woodgrain Textured Fiberglass	•	•	•	•		•	•	•	•	•		•	•	•		•				•
Heritage Smooth Fiberglass	•	•	•	•		•	•	•	•	•		•	•	•		•				•
20-Gauge Woodgrain Textured Steel	•	•	•		•		•		•	•		○	○	○						
20-Gauge Smooth Steel	•	•	•	•			•	•	•	•		○	○	○						
Price List Page Number	44	35	49	51	39	32	18	23	11	8	17	67	65	62	86	79	84	93	91	
Price List Page Number (for Embarq)	141	138		143		136	134	24	133			147	146	145						

† For additional door panel styles see pg. 14 (for Embarq®), pg. 18 (for Signet®), pg. 20 (for Heritage™) or pg. 22 (for Legacy™)

○ Steel sidelites are made from 24-Gauge steel

* Embarq doors and sidelites are not available in 8' heights

⚠ Cannot be mulled with Heritage Fiberglass doors in Certified Wind Load regions



BRILLIANCE

DECORATIVE GLASS

Brilliance features micro-granite and hammered glass with artistic beveled glass detailing and is sure to make a lasting impression.

CAMING FINISH

Patina

Zinc

Specify caming finish using these codes:
Patina - BRP, Zinc - BRZ

PRIVACY RATING

1 2 3 4 5 6 7 **8** 9 10

less privacy more privacy

LIFETIME LIMITED WARRANTY
Includes Glass Breakage & Seal Failure



460BRZ, 160BRZ, 512/513BRZ



All Full Wood Frame and Composite Frame Entry Systems using Brilliance Glass are ENERGY STAR® Certified and some Steel L-Frame Entry Systems using Brilliance Glass are ENERGY STAR Certified. See the ENERGY STAR section of our website for energy ratings on specific styles.

512/513BRZ ☼ pg. 100



Brilliance Glass

BRILLIANCE STYLE AVAILABILITY

	Doors									Sidelites			8' Doors			8' Sidelites		
	460	440	150	240	243	430	230	419	400	160	140	130	440	430	150	140	130	
Embarq / Signet Mahogany Series	•	•	•			•		•		•	•	•						
Embarq / Signet Cherry Series	•	•	•		•	•		•		•	•	•	*		*		*	
Embarq / Signet Oak Series	•	•	•		•	•		•		•	•	•						
Embarq / Signet Knotty Alder Series	•					•								*			*	
Signet Smooth Series	•	•	•							•	•							
Heritage Woodgrain Textured Fiberglass	•	•	•		•	•	•	•	•	•	•	•		•				•
Heritage Smooth Fiberglass	•	•	•		•	•	•	•	•	•	•	•		•				•
20-Gauge Woodgrain Textured Steel	•	•		•		•		•	•	○	○	○						
20-Gauge Smooth Steel	•	•	•	•	•	•	•	•	•	○	○	○						•
Price List Page Number	44	35	51	39	32	18	23	11	8	67	65	62	86	79	84	93	91	
Price List Page Number (for Embarq)	141	138	143		136	134		133		147	146	145						

† For additional door panel styles see pg. 14 (for Embarq®), pg. 18 (for Signet®), pg. 20 (for Heritage™) or pg. 22 (for Legacy™)

○ Steel sidelites are made from 24-Gauge steel

* Embarq doors and sidelites are not available in 8' heights

☼ Cannot be mulled with Heritage Fiberglass doors in Certified Wind Load regions



SYMPHONY

DECORATIVE GLASS

Symphony features a bronze softwave and expresses timeless beauty and elegance at every curve. This design is sure to bring you a pleasing and melodious style.

CAMING FINISH



Specify caming finish using these codes:
 Brass - SYB, Antique Brass - SYA, Zinc - SYZ

PRIVACY RATING



LIFETIME LIMITED WARRANTY
 Includes Glass Breakage & Seal Failure



460SYZ, 160SYZ, 612/613SYZ



All Full Wood Frame and Composite Frame Entry Systems using Symphony Glass are ENERGY STAR® Certified and some Steel L-Frame Entry Systems using Symphony Glass are ENERGY STAR Certified. See the ENERGY STAR section of our website for energy ratings on specific styles.

532SYA* ** pg. 105



160SYA 460SYA 160SYA

612/613SYA**⊕ pg. 102



140SYA 440SYA† 140SYA

712/713SYA**⊕ pg. 99

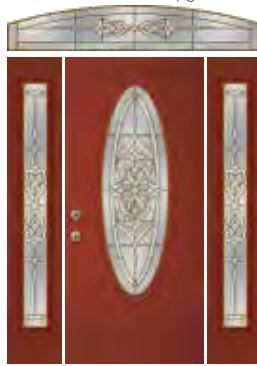

160SYA 350SYA 160SYA

512/513SYA**⊕ pg. 100



770SYA⊕§ 449SYA† 770SYA⊕§

516SYA* ** pg. 105



150SYA†



240SYA



243SYA



130SYA



430SYA†



230SYA



120SYA

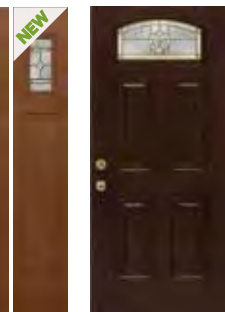

420SYA-DS



120SYA



419SYA†



400SYA†



8' DOORS

460SYA

160SYA

440SYA†

140SYA

430SYA†

130SYA

437SYA†

150SYA

SYMPHONY STYLE AVAILABILITY

	Doors										Sidelites					8' Doors					8' Sidelites					
	460	440	350	449	150	240	243	430	230	420	419	400	160	140	770	130	120	460	440	430	437	150	160	140	130	
Embarq / Signet Mahogany Series	•	•			•			•			•		•	•	•	•	•									
Embarq / Signet Cherry Series	•	•		•				•			•		•	•	•	•	•		*			*				*
Embarq / Signet Oak Series	•	•			•			•			•		•	•	•	•	•									
Signet Fir Series										•			•	•		•										
Embarq / Signet Knotty Alder Series	•							•					•	•						*	*					*
Signet Smooth Series	•	•			•								•	•	•											
Heritage Woodgrain Textured Fiberglass	•	•	•		•			•	•	•		•	•	•	•	•	•		•	•				•	•	•
Heritage Smooth Fiberglass	•	•	•		•			•	•	•		•	•	•	•	•	•		•	•				•	•	•
20-Gauge Woodgrain Textured Steel	•	•	•		•			•	•	•		•	•	•	•	•	•									
20-Gauge Smooth Steel	•	•	•		•			•	•	•		•	•	•	•	•	•									
Price List Page Number	44	35	49	43	51	39	32	18	24	14	11	8	67	65	75	62	60	88	86	79	83	84	95	93	91	
Price List Page Number (for Embarq)	141	138		140	143		137	134		133			147	146	150	145										

§ Also available in 10" width (which requires an additional 4-week lead time). See Price List for design pattern
 ** Requires an additional 4-week lead time
 * Embarq doors and sidelites are not available in 8' heights

† For additional door panel styles see pg. 14 (for Embarq®), pg. 18 (for Signet®), pg. 20 (for Heritage™) or pg. 22 (for Legacy™)
 ○ Steel sidelites are made from 24-Gauge steel
 ⊕ Cannot be milled with Heritage Fiberglass doors in Certified Wind Load regions
 * In Certified Wind Load region, indicated transoms must be installed in a separate opening or use approved engineering mulls

Symphony Glass



BERKLEY

DECORATIVE GLASS

Berkley features micro-iced granite, clear bevels, and small hammered with a timeless herringbone pattern that complements modern, contemporary and Arts & Crafts architecture.

CAMING FINISH

Antique Brass

Zinc

Specify caming finish using these codes:
Antique Brass - BEA, Zinc - BEZ

PRIVACY RATING

1 2 3 4 5 6 **7** 8 9 10

less privacy more privacy

LIFETIME LIMITED WARRANTY
Includes Glass Breakage & Seal Failure



460BEZ, 160BEZ



All Full Wood Frame and Composite Frame Entry Systems using Berkley Glass are ENERGY STAR® Certified and some Steel L-Frame Entry Systems using Berkley Glass are ENERGY STAR Certified. See the ENERGY STAR section of our website for energy ratings on specific styles.

612/613BEA** † pg. 102



160BEA 460BEA 160BEA



140BEA 440BEA† 140BEA



770BEA‡§ 240BEA 770BEA‡§



130BEA 430BEA†



230BEA

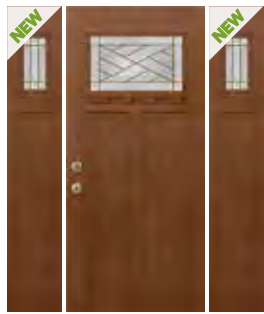

160BEA 420BEA-DS 160BEA

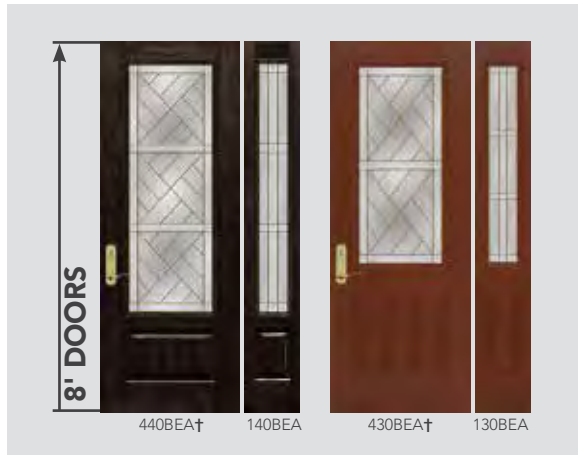

BERKLEY STYLE AVAILABILITY

	Doors						Sidelites					8' Doors		8' Sidelites	
	460	440	240	430	230	420	160	140	770	130	120	440	430	140	130
Embarq / Signet Mahogany Series	•	•		•			•	•	•	•					
Embarq / Signet Cherry Series	•	•		•			•	•	•	•		*		*	
Embarq / Signet Oak Series	•	•		•			•	•	•	•					
Signet Fir Series						•	•	•		•					
Signet Smooth Series	•	•					•	•	•						
Embarq / Signet Knotty Alder Series	•			•			•	•				*		*	
Heritage Woodgrain Textured Fiberglass	•	•		•	•		•	•	•	•			•		•
Heritage Smooth Fiberglass	•	•		•	•		•	•	•	•			•		•
20-Gauge Woodgrain Textured Steel	•	•	•	•	•		○	○	•	○					
20-Gauge Smooth Steel	•	•	•	•	•		○	○	•	○			•		•
Price List Page Number	44	35	39	18	24	14	67	65	75	62	60	85	79	93	91
Price List Page Number (for Embarq)	141	138		134			147	146	150						

§ Also available in 10" width (which requires an additional 4-week lead time). See Price List for design pattern

** Requires an additional 4-week lead time

* Embarq doors and sidelites are not available in 8' heights

† For additional door panel styles see pg. 14 (for Embarq®), pg. 18 (for Signet®), pg. 20 (for Heritage™) or pg. 22 (for Legacy™)

○ Steel sidelites are made from 24-Gauge steel

‡ Cannot be mulled with Heritage Fiberglass doors in Certified Wind Load regions



LAURENCE

DECORATIVE GLASS

Laurence features a gray softwave expressing defined classical vintage that will greet your guests with its distinguished character and prominent lines.

CAMING FINISH

Patina

PRIVACY RATING

1 2 3 4 5 **6** 7 8 9 10

less privacy more privacy

LIFETIME LIMITED WARRANTY
Includes Glass Breakage & Seal Failure



460LAU, 160LAU,



All Full Wood Frame and Composite Frame Entry Systems using Laurence Glass are ENERGY STAR® Certified and some Steel L-Frame Entry Systems using Laurence Glass are ENERGY STAR Certified. See the ENERGY STAR section of our website for energy ratings on specific styles.

612/613LAU* pg. 102

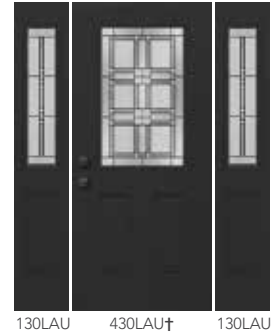
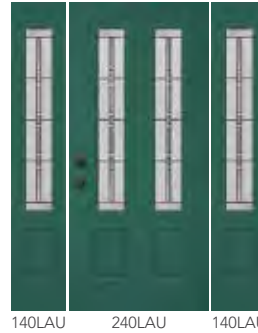
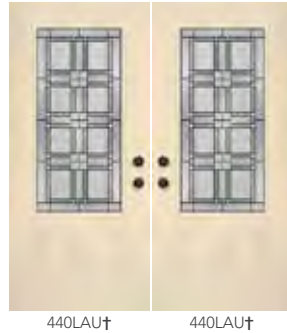

LAURENCE STYLE AVAILABILITY

	Doors						Sidelites				8' Doors		8' Sidelites	
	460	440	240	430	230	420	160	140	130	120	440	430	140	130
Embarq / Signet Mahogany Series	•	•		•			•	•	•					
Embarq / Signet Cherry Series	•	•		•			•	•	•		*		*	
Embarq / Signet Oak Series	•	•		•			•	•	•					
Signet Fir Series						•	•			•				
Signet Smooth Series	•	•					•	•						
Embarq / Signet Knotty Alder Series	•			•			•					*	*	
Heritage Woodgrain Textured Fiberglass	•	•		•	•	•	•	•	•			•		•
Heritage Smooth Fiberglass	•	•		•	•	•	•	•	•			•		•
20-Gauge Woodgrain Textured Steel	•	•	•	•	•	•	o	o	o					
20-Gauge Smooth Steel	•	•	•	•	•	•	o	o	o			•		•
Price List Page Number	45	36	40	19	25	14	68	65	62	60	86	80	93	91
Price List Page Number (for Embarq)	141	138		135			147	146	145					

† For additional door panel styles see pg. 14 (for Embarq®), pg. 18 (for Signet®), pg. 20 (for Heritage™) or pg. 22 (for Legacy™)

o Steel sidelites are made from 24-Gauge steel

* Embarq doors and sidelites are not available in 8' heights

* Cannot be mulled with Heritage Fiberglass doors in Certified Wind Load regions



CARRINGTON

DECORATIVE GLASS

Carrington features small hammered, flat seedy and clear bevels in an attractive vintage design to accent your home's entryway.

CAMING FINISH

Patina

PRIVACY RATING

1 2 3 4 **5** 6 7 8 9 10
 less privacy more privacy

LIFETIME LIMITED WARRANTY
 Includes Glass Breakage & Seal Failure



460CAR, 160CAR



All Full Wood Frame and Composite Frame Entry Systems using Carrington Glass are ENERGY STAR® Certified and some Steel L-Frame Entry Systems using Carrington Glass are ENERGY STAR Certified. See the ENERGY STAR section of our website for energy ratings on specific styles.



Carrington Glass

CARRINGTON STYLE AVAILABILITY

	Doors									Sidelites					8' Doors			8' Sidelites	
	460	440	449	240	243	430	230	420	419	160	140	770	130	120	440	430	437	140	130
Embarq / Signet Mahogany Series	•	•				•			•	•	•	•							
Embarq / Signet Cherry Series	•	•	•		•	•			•	•	•	•			*			*	
Embarq / Signet Oak Series	•	•			•	•			•	•	•	•							
Signet Fir Series								•		•				•					
Signet Smooth Fiberglass	•	•								•	•	•							
Embarq / Signet Knotty Alder Series	•					•				•	•					*	*	*	
Heritage Woodgrain Textured Fiberglass	•	•			•	•	•		•	•	•	•				•			•
Heritage Smooth Fiberglass	•	•			•	•	•		•	•	•	•				•			•
20-Gauge Woodgrain Textured Steel	•	•		•		•			•	○	○	•	○						
20-Gauge Smooth Steel	•	•		•		•	•		•	○	○	•	○			•			•
Price List Page Number	44	35	43	39	32	18	24	14	11	67	65	75	62	60	86	79	83	93	91
Price List Page Number (for Embarq)	141	138	140		137	134			133	147	146	150	145						

§ Also available in 10" width (which requires an additional 4-week lead time). See Price List for design pattern

** Requires an additional 4-week lead time

* Embarq doors and sidelites are not available in 8' heights

† For additional door panel styles see pg. 14 (for Embarq®), pg. 18 (for Signet®), pg. 20 (for Heritage™) or pg. 22 (for Legacy™)

○ Steel sidelites are made from 24-Gauge steel

✪ Cannot be mulled with Heritage Fiberglass doors in Certified Wind Load regions



TACOMA

DECORATIVE GLASS

Tacoma features hammered and micro-granite design reminiscent of the Arts and Crafts period. Tacoma adds a southwestern inspired theme bringing heritage and legacy to your door.

CAMING FINISH

Patina

PRIVACY RATING

1 2 3 4 5 **6** 7 8 9 10

less privacy

more privacy

LIFETIME LIMITED WARRANTY

Includes Glass Breakage & Seal Failure



420TAC-DS, 160TAC, 612/613TAC



All Full Wood Frame and Composite Frame Entry Systems using Tacoma Glass are ENERGY STAR® Certified and some Steel L-Frame Entry Systems using Tacoma Glass are ENERGY STAR Certified. See the ENERGY STAR section of our website for energy ratings on specific styles.

612/613TAC ♡ pg. 102



160TAC 460TAC 160TAC

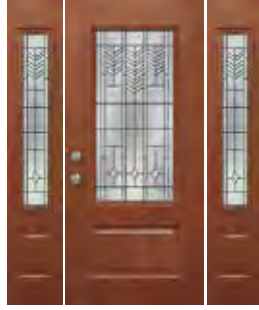

140TAC 440TAC† 140TAC

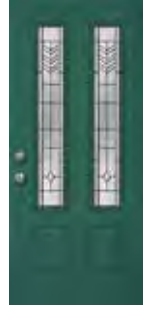

240TAC



160TAC 420TAC-DS 160TAC



8' DOORS

440TAC† 140TAC 430TAC† 130TAC

TACOMA STYLE AVAILABILITY

	Doors				Sidelites			8' Doors		8' Sidelites	
	460	440	240	420	160	140	120	440	430	140	130
Embarq / Signet Mahogany Series	●	●			●	●					
Embarq / Signet Cherry Series	●	●			●	●		*		*	
Embarq / Signet Oak Series	●	●			●	●					
Embarq / Signet Knotty Alder Series	●				●				*	*	
Signet Fir Series			●		●		●				
Signet Smooth Series	●	●			●	●					
Heritage Woodgrain Textured Fiberglass	●	●			●	●			●		●
Heritage Smooth Fiberglass	●	●			●	●			●		●
20-Gauge Woodgrain Textured Steel	●	●	●		○	○					
20-Gauge Smooth Steel	●	●	●		○	○			●		●
Price List Page Number	44	35	39	14	67	65	60	86	79	93	91
Price List Page Number (for Embarq)	141	138			147	146					

† For additional door panel styles see pg. 14 (for Embarq®), pg. 18 (for Signet®), pg. 20 (for Heritage™) or pg. 22 (for Legacy™)

○ Steel sidelites are made from 24-Gauge steel

* Embarq doors and sidelites are not available in 8' heights

♡ Cannot be mulled with Heritage Fiberglass doors in Certified Wind Load regions



Zinc Caming

Micro-granite

Clear Beveled

Small Hammered

SOMERSET

DECORATIVE GLASS

Somerset features small hammered, micro granite and clear bevels in a simple yet elegant design that gives a fresh look to your entryway.

CAMING FINISH

Zinc

PRIVACY RATING

1 2 3 4 5 **6** 7 8 9 10

less privacy more privacy

LIFETIME LIMITED WARRANTY
Includes Glass Breakage & Seal Failure



449SOM-1P, 140SOM



All Full Wood Frame Entry Systems using Somerset Glass are ENERGY STAR® Certified and some Steel L-Frame Entry Systems using Somerset Glass are ENERGY STAR Certified. See the ENERGY STAR section of our website for energy ratings on specific styles.

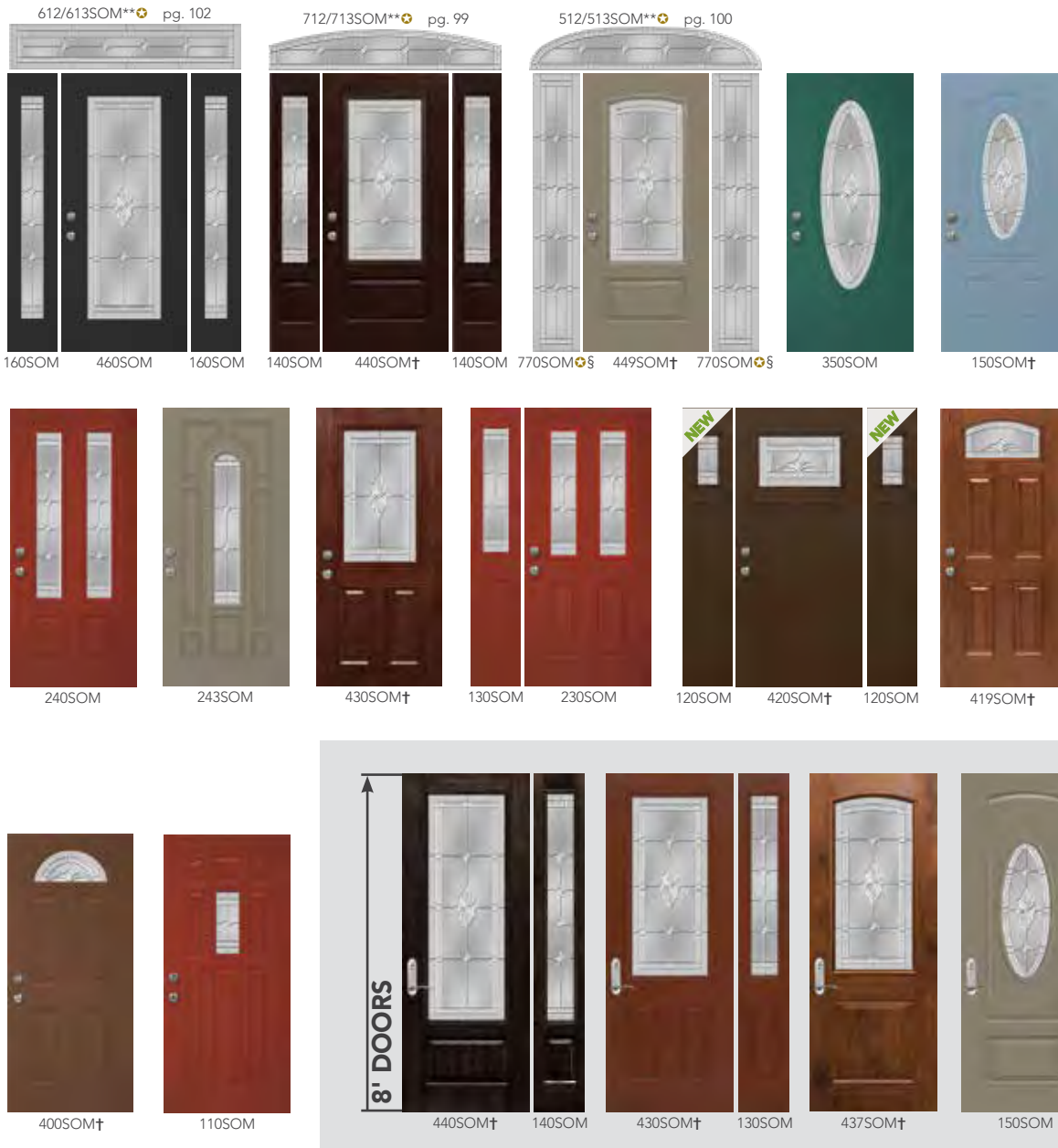

Somerset Glass

SOMERSET STYLE AVAILABILITY

	Doors											Sidelites					8' Doors				8' Sidelites			
	460	440	449	350	150	240	243	430	230	420	419	400	110	160	140	770	130	120	440	430	437	150	140	130
Embarq / Signet Mahogany Series	•	•			•			•			•			•	•	•	•							
Embarq / Signet Cherry Series	•	•	•		•		•	•			•			•	•	•	•			*		*		*
Embarq / Signet Oak Series	•	•			•		•	•			•			•	•	•	•							
Signet Fir Series										•				•		•		•						
Embarq / Signet Knotty Alder Series	•							•						•		•					*	*		*
Signet Smooth Series	•	•			•									•	•	•								
Heritage Woodgrain Textured Fiberglass	•	•		•	•		•	•	•	•	•	•	•	•	•	•	•				•			•
Heritage Smooth Fiberglass	•	•		•	•		•	•	•	•	•	•	•	•	•	•	•				•			•
20-Gauge Woodgrain Textured Steel	•	•	•		•		•	•	•	•	•	•	•	○	○	•	○							
20-Gauge Smooth Steel	•	•		•	•		•	•	•	•	•	•	•	○	○	•	○				•			•
Price List Page Number	44	35	43	49	52	39	32	18	24	14	11	8	17	67	65	75	62	60	86	79	83	84	93	91
Price List Page Number (for Embarq)	141	138	139		143		137	134			133			147	146	150	145							

§ Also available in 10" width. See Price List for design pattern
 ** Requires an additional 4-week lead time
 ○ Steel sidelites are made from 24-Gauge steel
 * Embarq doors and sidelites are not available in 8' heights

† For additional door panel styles see pg. 14 (for Embarq®), pg. 18 (for Signet®), pg. 20 (for Heritage™) or pg. 22 (for Legacy™)
 ☼ Cannot be mulled with Heritage Fiberglass doors in Certified Wind Load regions



Wrought Iron with Nickel-Veined Finish

Chinchilla

CARMEN

WROUGHT IRON DECORATIVE GLASS

Carmen features a refreshing new style for an entrance way with old world style charm. Standard with Chinchilla privacy glass and also available in all privacy glass options.

CHINCHILLA PRIVACY RATING

1 2 3 4 5 6 7 8 **9** 10

less privacy

more privacy

LIFETIME LIMITED WARRANTY
Includes Glass Breakage & Seal Failure



460CRM, 160CRM



All Full Wood Frame and Composite Frame Entry Systems using Carmen Glass are ENERGY STAR® Certified and some Steel L-Frame Entry Systems using Carmen Glass are ENERGY STAR Certified. See the ENERGY STAR section of our website for energy ratings on specific styles.

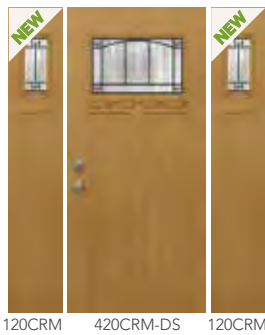
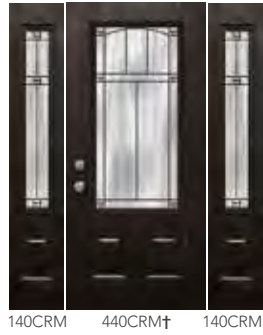
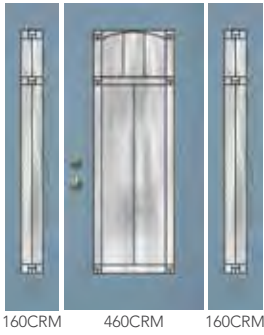

Carmen Glass

When you order Carmen glass using the style code CRM, you will receive the standard Chinchilla glass. To order the other Privacy Glass options shown below, use the style codes GLC, TAF, WAT or OBS after the letters CRM (e.g. 460CRM-GLC).



GLUECHIP

PRIVACY RATING



less privacy more privacy



TAFETA

PRIVACY RATING



less privacy more privacy



WATERFALL

PRIVACY RATING



less privacy more privacy



OBSCURE PEBBLE

PRIVACY RATING



less privacy more privacy

CARMEN STYLE AVAILABILITY

	Doors						Sidelites				8' Doors		8' Sidelites	
	460	440	240	430	230	420	160	140	130	120	440	430	140	130
Embarq / Signet Mahogany Series	●	●		●			●	●	●					
Embarq / Signet Cherry Series	●	●		●			●	●	●		*		*	
Embarq / Signet Oak Series	●	●		●			●	●	●					
Signet Fir Series						●	●			●				
Embarq / Signet Knotty Alder Series	●			●			●					*	*	
Signet Smooth Series	●	●					●	●						
Heritage Woodgrain Textured Fiberglass	●	●		●	●		●	●	●			●		●
Heritage Smooth Fiberglass	●	●		●	●		●	●	●			●		●
20-Gauge Woodgrain Textured Steel	●	●	●	●	●		○	○	○					
20-Gauge Smooth Steel	●	●	●	●	●		○	○	○			●		●
Price List Page Number	44	35	39	18	24	14	67	65	62	60	86	79	93	91
Price List Page Number (for Embarq)	141	138		134			147	146	145					

** Requires an additional 4-week lead time

* Embarq doors and sidelites are not available in 8' heights

† For additional door panel styles see pg. 14 (for Embarq®), pg. 18 (for Signet®), pg. 20 (for Heritage™) or pg. 22 (for Legacy™)

○ Steel sidelites are made from 24-Gauge steel

⚠ Cannot be mulled with Heritage Fiberglass doors in Certified Wind Load regions



Black Wrought Iron

Gluechip

BARCELONA

WROUGHT IRON DECORATIVE GLASS

Barcelona features an exquisite wrought iron design with the option of choosing gluechip (standard), waterfall, taffeta, chinchilla, obscure pebble or clear glass.

**GLUECHIP
PRIVACY RATING**



LIFETIME LIMITED WARRANTY
Includes Glass Breakage & Seal Failure



8' 440BRC-1P, 140BRC



All Full Wood Frame and Composite Frame Entry Systems using Barcelona Glass are ENERGY STAR® Certified and some Steel L-Frame Entry Systems using Barcelona Glass are ENERGY STAR Certified. See the ENERGY STAR section of our website for energy ratings on specific styles.

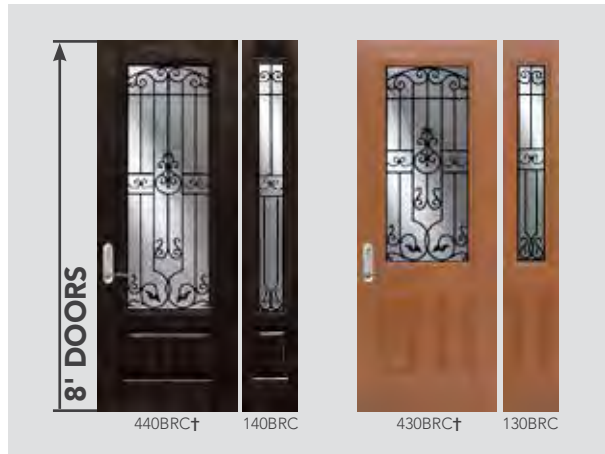
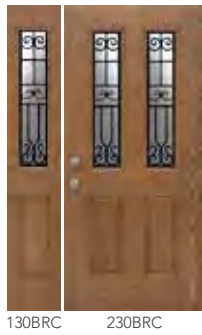
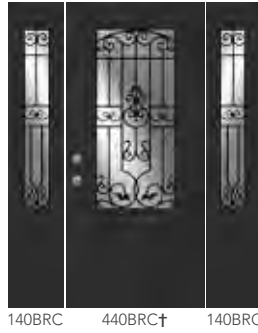

Barcelona Glass

When you order Barcelona glass using the style code BRC, you will receive the standard Gluechip glass. To order the other Privacy Glass options shown below, use the style codes CHI, TAF, WAT or OBS after the letters BRC (e.g. 460BRC-CHI).

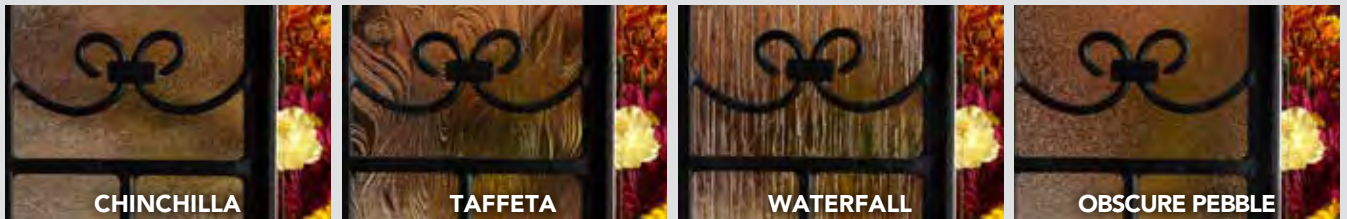

CHINCHILLA										TAFFETA										WATERFALL										OBSCURE PEBBLE									
PRIVACY RATING										PRIVACY RATING										PRIVACY RATING										PRIVACY RATING									
1	2	3	4	5	6	7	8	9	10	1	2	3	4	5	6	7	8	9	10	1	2	3	4	5	6	7	8	9	10	1	2	3	4	5	6	7	8	9	10
less privacy					more privacy					less privacy					more privacy					less privacy					more privacy														

BARCELONA STYLE AVAILABILITY

	Doors					Sidelites			8' Doors		8' Sidelites	
	460	440	240	430	230	160	140	130	440	430	140	130
Embarq / Signet Mahogany Series	•	•		•		•	•	•				
Embarq / Signet Cherry Series	•	•		•		•	•	•	*			*
Embarq / Signet Oak Series	•	•		•		•	•	•				
Embarq / Signet Knotty Alder Series	•			•		•				*		*
Signet Smooth Series	•	•				•	•					
Heritage Woodgrain Textured Fiberglass	•	•		•	•	•	•	•		•		•
Heritage Smooth Fiberglass	•	•		•	•	•	•	•		•		•
20-Gauge Woodgrain Textured Steel	•	•	•	•		o	o	o				
20-Gauge Smooth Steel	•	•	•	•	•	o	o	o		•		•
Price List Page Number	44	35	39	18	24	67	65	62	86	79	93	91
Price List Page Number (for Embarq)	141	138		135		147	146	145				

† For additional door panel styles see pg. 14 (for Embarq®), pg. 18 (for Signet®), pg. 20 (for Heritage™) or pg. 22 (for Legacy™)
 o Steel sidelites are made from 24-Gauge steel
 * Embarq doors and sidelites are not available in 8' heights



Lynford features clear bevels, gray softwave, seedy and streamed glass utilizing a first-ever 1/16" wide, finger-jointed aluminum caming without solder joints that brings a distinctive modern and contemporary feel to an entryway.

CAMING FINISH

Aluminum Zinc

PRIVACY RATING

1 2 3 4 5 6 **7** 8 9 10

less privacy

more privacy

LIFETIME LIMITED WARRANTY

Includes Glass Breakage & Seal Failure



440LYN-2P, 140LYN



All Full Wood Frame and Composite Frame Entry Systems using Lynford Glass are ENERGY STAR® Certified and some Steel L-Frame Entry Systems using Lynford Glass are ENERGY STAR Certified. See the ENERGY STAR section of our website for energy ratings on specific styles.

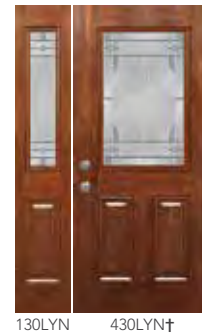
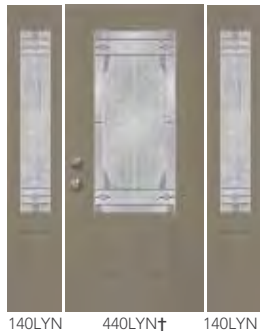

LYNFORD STYLE AVAILABILITY

	Doors						Sidelites				8' Doors		8' Sidelites	
	460	440	240	430	230	420	160	140	130	120	440	430	140	130
Embarq / Signet Mahogany Series	•	•		•			•	•	•					
Embarq / Signet Cherry Series	•	•		•			•	•	•		*		*	
Embarq / Signet Oak Series	•	•		•			•	•	•					
Signet Fir Series						•	•			•				
Embarq / Signet Knotty Alder Series	•			•			•					*	*	
Signet Smooth Series	•	•					•	•						
Heritage Woodgrain Textured Fiberglass	•	•		•	•		•	•	•		•			•
Heritage Smooth Fiberglass	•	•		•	•		•	•	•		•			•
20-Gauge Woodgrain Textured Steel	•	•	•	•			○	○	○					
20-Gauge Smooth Steel	•	•	•	•	•		○	○	○		•			•
Price List Page Number	45	36	40	18	24	14	67	65	62	60	86	79	93	91
Price List Page Number (for Embarq)	141	138		135			147	146	145					

§ Also available in 10" width (which requires an additional 4-week lead time). See Price List for design pattern

** Requires an additional 4-week lead time

* Embarq doors and sidelites are not available in 8' heights

† For additional door panel styles see pg. 14 (for Embarq®), pg. 18 (for Signet®), pg. 20 (for Heritage™) or pg. 22 (for Legacy™)

○ Steel sidelites are made from 24-Gauge steel

⚠ Cannot be mulled with Heritage Fiberglass doors in Certified Wind Load regions



CONSTANCE

DECORATIVE GLASS

Constance features gluechip, medium gray softwave and beveled edge glue chip resulting in a traditional design that gives your entryway an elegant look.

CAMING FINISH



Specify caming finish using these codes:
Brass - COB, Zinc - COZ

PRIVACY RATING



less privacy more privacy

LIFETIME LIMITED WARRANTY
Includes Glass Breakage & Seal Failure



449COB-1P, 770COB, 512/513COB



All Full Wood Frame and Composite Frame Entry Systems using Constance Glass are ENERGY STAR® Certified and some Steel L-Frame Entry Systems using Constance Glass are ENERGY STAR Certified. See the ENERGY STAR section of our website for energy ratings on specific styles.



Constance Glass

CONSTANCE STYLE AVAILABILITY

	Doors											Sidelites					8' Doors				8' Sidelites				
	460	440	449	350	150	240	243	430	230	420	419	400	110	160	140	770	130	120	440	430	437	150	140	130	
Embarq / Signet Mahogany Series	•	•			•			•			•			•	•	•	•								
Embarq / Signet Cherry Series	•	•	•			•		•		•				•	•	•	•			*		*		*	
Embarq / Signet Oak Series	•	•			•			•		•				•	•	•	•								
Signet Fir Series										•				•		•		•							
Signet Smooth Series	•	•			•									•	•	•									
Embarq / Signet Knotty Alder Series	•							•						•	•						*	*		*	
Heritage Woodgrain Textured Fiberglass	•	•	•	•	•	•	•	•	•	•	•	•	•	•	•	•	•	•							•
Heritage Smooth Fiberglass	•	•	•	•	•	•	•	•	•	•	•	•	•	•	•	•	•	•							•
20-Gauge Woodgrain Textured Steel	•	•	•	•	•	•	•	•	•	•	•	•	•	○	○	○	○								
20-Gauge Smooth Steel	•	•	•	•	•	•	•	•	•	•	•	•	•	○	○	•	○								•
Price List Page Number	45	36	43	49	52	40	32	19	24	14	11	8	17	67	65	75	62	60	86	80	83	84	93	91	
Price List Page Number (for Embarq)	141	138	140		143		137	135			133			147	146	150	145								

§ Also available in 10" width (which requires an additional 4-week lead time). See Price List for design pattern
 † For additional door panel styles see pg. 14 (for Embarq®), pg. 18 (for Signet®), pg. 20 (for Heritage™) or pg. 22 (for Legacy™)
 ○ Steel sidelites are made from 24-Gauge steel
 ** Requires an additional 4-week lead time
 * Embarq doors and sidelites are not available in 8' heights
 ⚠ Cannot be mulled with Heritage Fiberglass doors in Certified Wind Load regions



TRANQUILITY

DECORATIVE GLASS

Tranquility features unique Chinchilla glass accented with beveled clusters and streamed glass.

CAMING FINISH

- Patina
- Zinc

Specify caming finish using these codes:
Patina - TRP, Zinc - TRZ

PRIVACY RATING

- 1 2 3 4 5 6 7 **8** 9 10
- less privacy more privacy

LIFETIME LIMITED WARRANTY
Includes Glass Breakage & Seal Failure



350BRZ, 160BRZ



All Full Wood Frame and Composite Frame Entry Systems using Tranquility Glass are ENERGY STAR® Certified and some Steel L-Frame Entry Systems using Tranquility Glass are ENERGY STAR Certified. See the ENERGY STAR section of our website for energy ratings on specific styles.

612/613TRP † pg. 102



TRANQUILITY STYLE AVAILABILITY

	Doors											Sidelites			8' Doors			8' Sidelites		
	460	440	350	150	240	243	430	230	419	400	110	160	140	130	440	430	150	140	130	
Embarq / Signet Mahogany Series	•	•		•			•		•			•	•	•						
Embarq / Signet Cherry Series	•	•		•		•	•		•			•	•	•	*		*		*	
Embarq / Signet Oak Series	•	•		•		•	•		•			•	•	•						
Embarq / Signet Knotty Alder Series	•						•					•					*		*	
Signet Smooth Series	•	•		•								•	•							
Heritage Woodgrain Textured Fiberglass	•	•	•	•		•	•	•	•	•		•	•	•			•		•	
Heritage Smooth Fiberglass	•	•	•	•		•	•	•	•	•		•	•	•			•		•	
20-Gauge Woodgrain Textured Steel	•	•	•		•		•		•			○	○	○						
20-Gauge Smooth Steel	•	•	•	•	•		•	•	•	•	•	○	○	○			•		•	
Price List Page Number	45	36	49	52	40	32	19	24	11	8	17	67	65	62	86	80	84	93	91	
Price List Page Number (for Embarq)	141	138		143		137	135		133			147	146	145						

† For additional door panel styles see pg. 14 (for Embarq®), pg. 18 (for Signet®), pg. 20 (for Heritage™) or pg. 22 (for Legacy™)

○ Steel sidelites are made from 24-Gauge steel

* Embarq doors and sidelites are not available in 8' heights

⚡ Cannot be mulled with Heritage Fiberglass doors in Certified Wind Load regions

Tranquility Glass



GEMSTONE

DECORATIVE GLASS

Beautiful beveled glass with iced and micro-iced granite, accented with zinc caming, gives this classic design a contemporary edge.

CAMING FINISH

Zinc

PRIVACY RATING

1 2 3 4 5 6 7 **8** 9 10

less privacy more privacy

LIFETIME LIMITED WARRANTY
Includes Glass Breakage & Seal Failure



440GEM-2P, 140GEM, 612/613GEM



All Full Wood Frame and Composite Frame Entry Systems using Gemstone Glass are ENERGY STAR® Certified and some Steel L-Frame Entry Systems using Gemstone Glass are ENERGY STAR Certified. See the ENERGY STAR section of our website for energy ratings on specific styles.

612/613GEM ☼ pg. 102



160GEM 460GEM 160GEM



140GEM 440GEM† 140GEM



150GEM†



240GEM



243GEM



130GEM 430GEM†



230GEM



419GEM†



GEMSTONE STYLE AVAILABILITY

	Doors							Sidelites			8' Doors			8' Sidelites		
	460	440	150	240	243	430	230	419	160	140	130	440	430	150	140	130
Embarq / Signet Mahogany Series	•	•	•			•		•	•	•	•					
Embarq / Signet Cherry Series	•	•	•		•	•		•	•	•	•	*		*		*
Embarq / Signet Oak Series	•	•	•		•	•		•	•	•	•					
Embarq / Signet Knotty Alder Series	•					•			•				*			*
Signet Smooth Series	•	•	•						•	•	•					
Heritage Woodgrain Textured Fiberglass	•	•	•		•	•	•	•	•	•	•		•			•
Heritage Smooth Fiberglass	•	•	•		•	•	•	•	•	•	•		•			•
20-Gauge Woodgrain Textured Steel	•	•		•		•		•	○	○	○					
20-Gauge Smooth Steel	•	•	•	•		•	•	•	○	○	○		•			•
Price List Page Number	45	36	52	40	32	19	25	11	68	65	62	85	80	84	93	91
Price List Page Number (for Embarq)	141	138	143		137	135		133	147	146	145					

† For additional door panel styles see pg. 14 (for Embarq®), pg. 18 (for Signet®), pg. 20 (for Heritage™) or pg. 22 (for Legacy™)

○ Steel sidelites are made from 24-Gauge steel

* Embarq doors and sidelites are not available in 8' heights

☼ Cannot be mulled with Heritage Fiberglass doors in Certified Wind Load regions

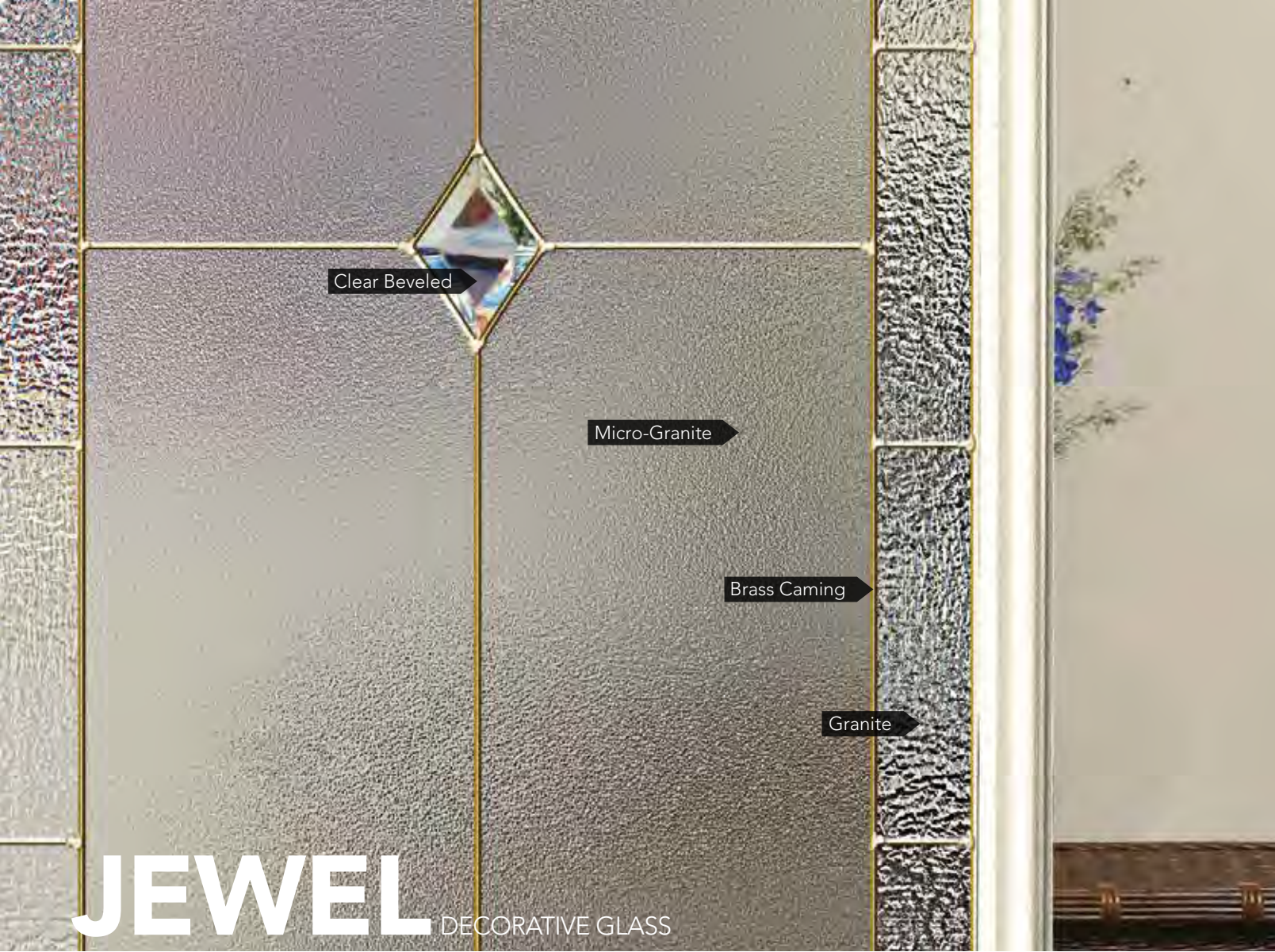

JEWEL

DECORATIVE GLASS

Simple, contemporary and classy all describe the elegant look and feel created with granite and micro-granite glass with beveled accents.

CAMING FINISH



PRIVACY RATING



less privacy more privacy

LIFETIME LIMITED WARRANTY
Includes Glass Breakage & Seal Failure



460JWL, 160JWL



All Full Wood Frame and Composite Frame Entry Systems using Jewel Glass are ENERGY STAR® Certified and some Steel L-Frame Entry Systems using Jewel Glass are ENERGY STAR Certified. See the ENERGY STAR section of our website for energy ratings on specific styles.

612/613JWL † pg. 102



160JWL 460JWL 160JWL

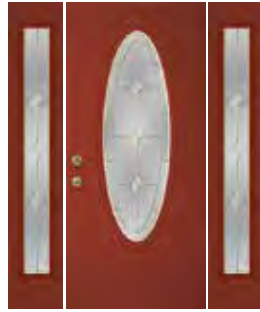

160JWL 350JWL 160JWL



130JWL 430JWL†



230JWL



400JWL†



440JWL† 140JWL

JEWEL STYLE AVAILABILITY

	Doors					Sidelites		8' Doors	8' Sidelites
	460	350	430	230	400	160	130	440	140
Embarq / Signet Mahogany Series	•		•			•	•		
Embarq / Signet Cherry Series	•					•	•	*	*
Embarq / Signet Oak Series	•		•			•	•		
Embarq / Signet Knotty Alder Series	•		•			•			*
Signet Smooth Series	•					•			
Heritage Woodgrain Textured Fiberglass	•	•	•	•	•	•	•		
Heritage Smooth Fiberglass	•	•	•	•	•	•	•		
20-Gauge Woodgrain Textured Steel	•	•	•		•	○	○		
20-Gauge Smooth Steel	•	•	•	•	•	○	○		
Price List Page Number	45	49	19	24	8	67	62	86	93
Price List Page Number (for Embarq)	141		135			147	145		

† For additional door panel styles see pg. 14 (for Embarq®), pg. 18 (for Signet®), pg. 20 (for Heritage™) or pg. 22 (for Legacy™)

○ Steel sidelites are made from 24-Gauge steel

* Embarq doors and sidelites are not available in 8' heights

‡ Cannot be mulled with Heritage Fiberglass doors in Certified Wind Load regions



Eclipse features double gluechip and clusters of bevel with a traditional and harmonious design. Eclipse promotes classical elegance and privacy.

CAMING FINISH



Specify caming finish using these codes:
Brass - ECB, Zinc - ECZ

PRIVACY RATING



less privacy more privacy

LIFETIME LIMITED WARRANTY
Includes Glass Breakage & Seal Failure



150ECZ-2P, 160ECZ, 612/613ECZ



All Full Wood Frame and Composite Frame Entry Systems using Eclipse Glass are ENERGY STAR® Certified and some Steel L-Frame Entry Systems using Eclipse Glass are ENERGY STAR Certified. See the ENERGY STAR section of our website for energy ratings on specific styles.

612/613ECB ✪ pg. 102



160ECB 460ECB 160ECB 350ECB 150ECB† 243ECB 130ECB 430ECB† 439ECB†



230ECB 419ECB† 400ECB† 110ECB



8' DOORS 440ECB† 140ECB 150ECB

ECLIPSE STYLE AVAILABILITY

	Doors										Sidelites		8' Doors		8' Sidelites
	460	350	150	243	430	439	230	419	400	110	160	130	440	150	140
Embarq / Signet Mahogany Series	•		•		•			•			•	•			
Embarq / Signet Cherry Series	•		•	•	•			•			•	•	*	*	*
Embarq / Signet Oak Series	•		•	•	•			•			•	•			
Embarq / Signet Knotty Alder Series	•				•						•				*
Signet Smooth Series	•		•								•				
Heritage Woodgrain Textured Fiberglass	•	•	•	•	•	•	•	•	•		•	•			
Heritage Smooth Fiberglass	•	•	•	•	•	•	•	•	•		•	•			
20-Gauge Woodgrain Textured Steel	•	•			•	•		•	•		○	○			
20-Gauge Smooth Steel	•	•	•		•	•	•	•	•	•	○	○			
Price List Page Number	45	49	52	32	19	29	25	11	8	17	68	62	86	84	93
Price List Page Number (for Embarq)	141		143	137	135			133			147	145			

† For additional door panel styles see pg. 14 (for Embarq®), pg. 18 (for Signet®), pg. 20 (for Heritage™) or pg. 22 (for Legacy™)

○ Steel sidelites are made from 24-Gauge steel

* Embarq doors and sidelites are not available in 8' heights

✪ Cannot be mulled with Heritage Fiberglass doors in Certified Wind Load regions

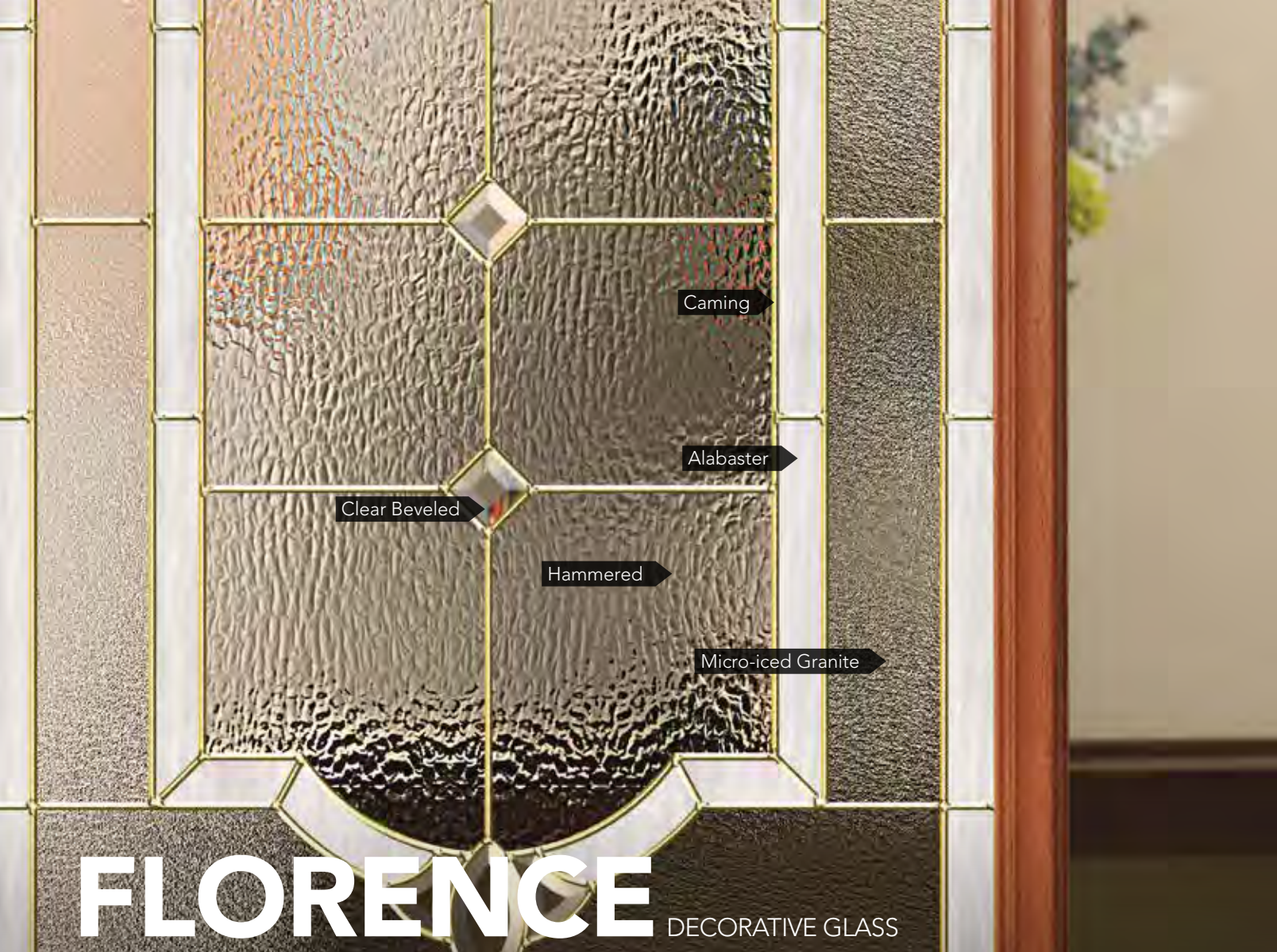

FLORENCE

DECORATIVE GLASS

This traditional style is accented with a creamy alabaster glass adding interest and appeal that clearly sets it apart from other decorative designs.

CAMING FINISH



Specify caming finish using these codes:
Brass - FLB, Patina - FLP

PRIVACY RATING



less privacy more privacy

LIFETIME LIMITED WARRANTY
Includes Glass Breakage & Seal Failure



150FLP, 160FLP



All Full Wood Frame and Composite Frame Entry Systems using Florence Glass are ENERGY STAR® Certified and some Steel L-Frame Entry Systems using Florence Glass are ENERGY STAR Certified. See the ENERGY STAR section of our website for energy ratings on specific styles.

612/613FLP pg. 102

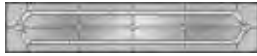

160FLP 460FLP 160FLP



140FLP 440FLP† 140FLP



160FLP 350FLP 160FLP



150FLP†



240FLP



243FLP

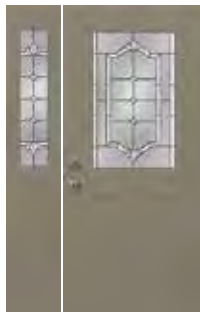

130FLP 430FLP†

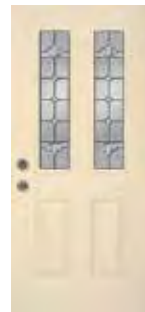

230FLP



419FLP†



400FLP†



8' DOORS

440FLP† 140FLP 430FLP† 130FLP 150FLP

FLORENCE STYLE AVAILABILITY

	Doors									Sidelites			8' Doors			8' Sidelites			
	460	440	350	150	240	243	430	230	419	400	160	140	130	440	430	150	140	130	
Embarq / Signet Mahogany Series	•	•		•			•		•		•	•	•						
Embarq / Signet Cherry Series	•	•	•			•	•		•		•	•	•	*		*		*	
Embarq / Signet Oak Series	•	•	•			•	•		•		•	•	•						
Embarq / Signet Knotty Alder Series	•						•				•				*			*	
Heritage Woodgrain Textured Fiberglass	•	•	•	•		•	•	•	•	•	•	•	•						•
Signet Smooth Series	•	•		•							•	•							
Heritage Smooth Fiberglass	•	•	•	•		•	•	•	•	•	•	•	•						•
20-Gauge Woodgrain Textured Steel	•	•	•		•		•		•	•	○	○	○						
20-Gauge Smooth Steel	•	•	•	•		•	•	•	•	•	○	○	○						
Price List Page Number	45	36	49	52	40	32	19	25	11	8	68	66	62	86	80	84	93	91	
Price List Page Number (for Embarq)	141	138		143		137	135		133		147	146	145						

† For additional door panel styles see pg. 14 (for Embarq®), pg. 18 (for Signet®), pg. 20 (for Heritage™) or pg. 22 (for Legacy™)

○ Steel sidelites are made from 24-Gauge steel

* Embarq doors and sidelites are not available in 8' heights

☼ Cannot be mulled with Heritage Fiberglass doors in Certified Wind Load regions



ESMOND

DECORATIVE GLASS

Esmond features small hammered, micro-granite, flat seedy and clear bevels in a splendid old-world style design bringing a unique touch to your entryway.

CAMING FINISH

Patina

PRIVACY RATING

1 2 3 4 5 **6** 7 8 9 10

less privacy

more privacy

LIFETIME LIMITED WARRANTY
Includes Glass Breakage & Seal Failure



460ESM, 160ESM



All Full Wood Frame and Composite Frame Entry Systems using Esmond Glass are ENERGY STAR® Certified and some Steel L-Frame Entry Systems using Esmond Glass are ENERGY STAR Certified. See the ENERGY STAR section of our website for energy ratings on specific styles.



Esmond Glass

ESMOND STYLE AVAILABILITY

	Doors													Sidelites						8' Doors				8' Sidelites							
	460	440	449	350	150	240	243	430	439	230	239	420	419	400	160	140	770	130	139	120	440	430	437	150	140	130					
Embarq / Signet Mahogany Series	•	•			•		•					•		•	•	•	•														
Embarq / Signet Cherry Series	•	•	•		•		•	•				•		•	•	•	•					*		*	*						
Embarq / Signet Oak Series	•	•			•		•	•				•		•	•	•	•														
Signet Fir Series											•			•	•					•											
Embarq / Signet Knotty Alder Series	•						•							•	•							*	*	*							
Signet Smooth Series	•	•			•							•		•	•	•															
Heritage Woodgrain Textured Fiberglass	•	•		•	•		•	•	•			•	•	•	•	•	•					•		•							
Heritage Smooth Fiberglass	•	•		•	•		•	•	•			•	•	•	•	•	•					•		•							
20-Gauge Woodgrain Textured Steel	•	•	•	•	•		•	•	•	•	•	•	•	•	•	•	•	•	•	•											
20-Gauge Smooth Steel	•	•		•	•	•	•	•	•	•	•	•	•	•	•	•	•	•	•	•		•		•							
Price List Page Number	46	36	43	50	52	40	33	20	29	25	31	15	12	9	68	66	75	63	64	60	87	80	83	84	94	91					
Price List Page Number (for Embarq)	142	138	140		143		137	135					133		147	146	150	145													

§ Also available in 10" width (which requires an additional 4-week lead time). See Price List for design pattern

** Requires an additional 4-week lead time

* Embarq doors and sidelites are not available in 8' heights

† For additional door panel styles see pg. 14 (for Embarq®), pg. 18 (for Signet®), pg. 20 (for Heritage™) or pg. 22 (for Legacy™)

○ Steel sidelites are made from 24-Gauge steel

⊛ Cannot be mulled with Heritage Fiberglass doors in Certified Wind Load regions

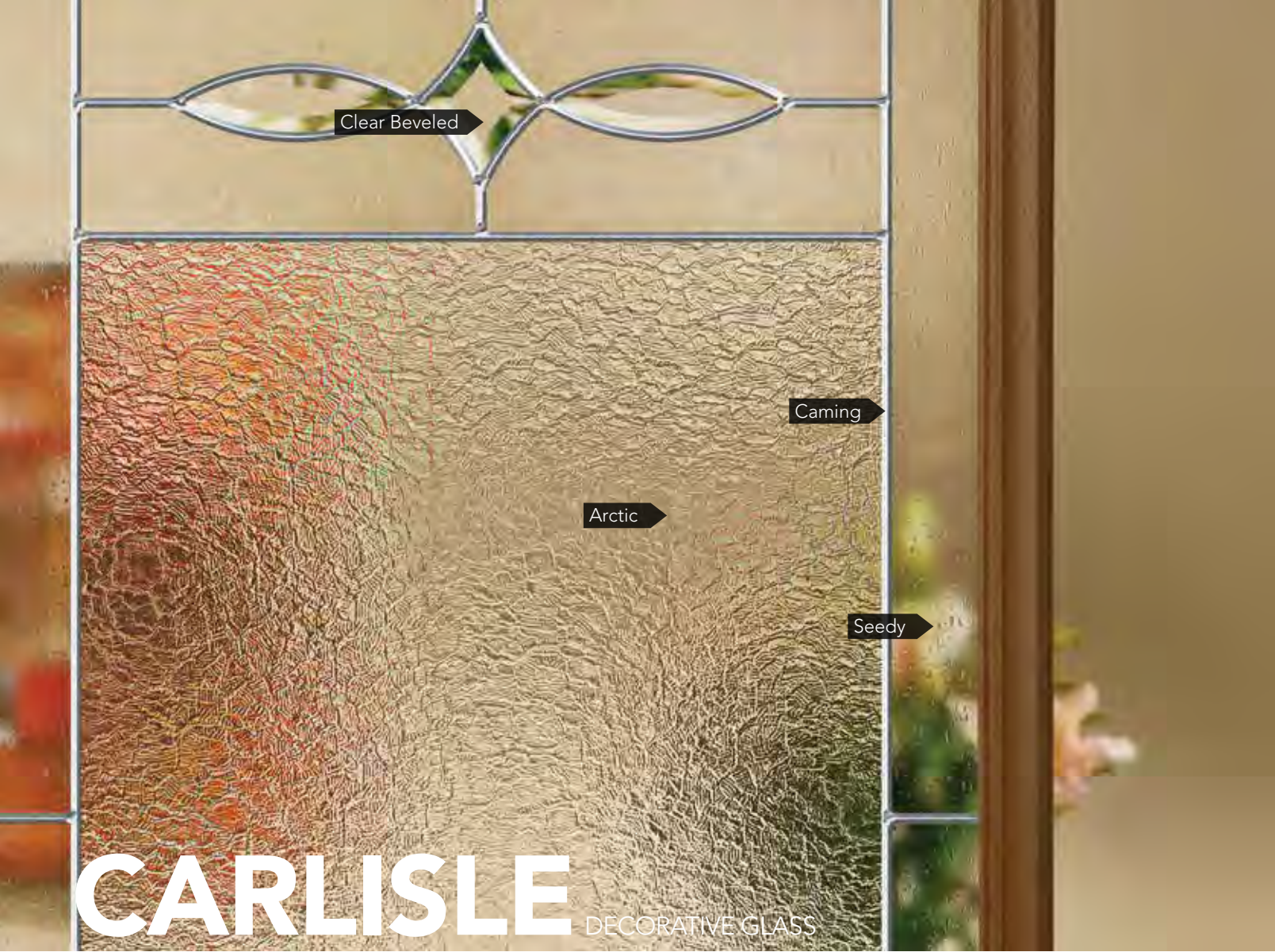

Carlisle features clear bevels, arctic and seedy glass giving an appealing entranceway to any style of home.

CAMING FINISH

Patina

Zinc

Specify caming finish using these codes:
Patina - CRP, Zinc - CRZ

PRIVACY RATING

1 2 3 4 5 6 **7** 8 9 10

less privacy more privacy

LIFETIME LIMITED WARRANTY
Includes Glass Breakage & Seal Failure



460CRP, 160CRP, 712/713CRP



All Full Wood Frame and Composite Frame Entry Systems using Carlisle Glass are ENERGY STAR® Certified and some Steel L-Frame Entry Systems using Carlisle Glass are ENERGY STAR Certified. See the ENERGY STAR section of our website for energy ratings on specific styles.



Carlisle Glass

CARLISLE STYLE AVAILABILITY

	Doors											Sidelites					8' Doors				8' Sidelites		
	460	440	449	350	150	240	243	430	230	420	419	400	160	140	770	130	120	440	430	437	150	140	130
Embarq / Signet Mahogany Series	•	•			•			•			•		•	•	•	•							
Embarq / Signet Cherry Series	•	•	•		•		•	•			•		•	•	•	•		*			*		*
Embarq / Signet Oak Series	•	•			•		•	•			•		•	•	•	•							
Signet Fir Series									•								•						
Embarq / Signet Knotty Alder Series	•							•					•		•			*	*				*
Signet Smooth Series	•	•			•								•	•	•								
Heritage Woodgrain Textured Fiberglass	•	•		•	•		•	•		•	•		•	•	•	•						•	•
Heritage Smooth Fiberglass	•	•		•	•		•	•		•	•		•	•	•	•						•	•
20-Gauge Woodgrain Textured Steel	•	•		•	•		•	•		•	•		○	○	○	○							
20-Gauge Smooth Steel	•	•		•	•		•	•		•	•		○	○	○	○						•	•
Price List Page Number	45	36	43	49	52	40	33	19	25	14	12	9	68	66	75	62	60	86	80	83	84	93	91
Price List Page Number (for Embarq)	141	138	140		143		137	135			133		147	146	150	145							

§ Also available in 10" width (which requires an additional 4-week lead time). See Price List for design pattern

** Requires an additional 4-week lead time

* Embarq doors and sidelites are not available in 8' heights

† For additional door panel styles see pg. 14 (for Embarq®), pg. 18 (for Signet®), pg. 20 (for Heritage™) or pg. 22 (for Legacy™)

○ Steel sidelites are made from 24-Gauge steel

⊕ Cannot be mullied with Heritage Fiberglass doors in Certified Wind Load regions



BEVELED

DECORATIVE GLASS

Beveled is accented with the rich beauty of brass caming and gathers and displays sunlight in an exciting prism effect to brighten your entry.

CAMING FINISH



PRIVACY RATING



LIFETIME LIMITED WARRANTY
Includes Glass Breakage & Seal Failure



460BEV



All Full Wood Frame and Composite Frame Entry Systems using Beveled Glass are ENERGY STAR® Certified and some Steel L-Frame Entry Systems using Beveled Glass are ENERGY STAR Certified. See the ENERGY STAR section of our website for energy ratings on specific styles.

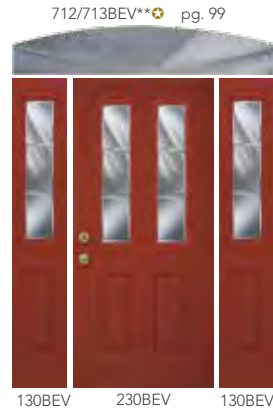
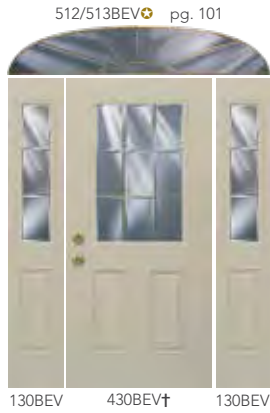
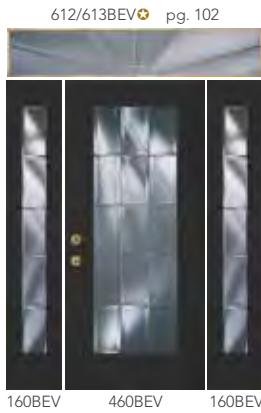

Beveled Glass

BEVELED STYLE AVAILABILITY

	Doors						Sidelites			8' Doors	8' Sidelites
	460	430	230	439	420	400	160	130	120	440	140
Embarq / Signet Mahogany Series	•	•					•	•			
Embarq / Signet Cherry Series	•	•					•	•		*	*
Embarq / Signet Oak Series	•	•					•	•			
Signet Fir Series					•				•		
Embarq / Signet Knotty Alder Series	•	•					•				*
Heritage Woodgrain Textured Fiberglass	•	•	•	•		•	•	•			
Signet Smooth Series	•						•				
Heritage Smooth Fiberglass	•	•	•	•		•	•	•			
20-Gauge Woodgrain Textured Steel	•	•		•		•	o	o			
20-Gauge Smooth Steel	•	•	•	•		•	o	o			
Price List Page Number	45	19	25	29		8	68	62	60	86	93
Price List Page Number (for Embarq)	141	135					147	145			

† For additional door panel styles see pg. 14 (for Embarq®), pg. 18 (for Signet®), pg. 20 (for Heritage™) or pg. 22 (for Legacy™)

** Requires an additional 4-week lead time

o Steel sidelites are made from 24-Gauge steel

* Embarq doors and sidelites are not available in 8' heights

† Cannot be mulled with Heritage Fiberglass doors in Certified Wind Load regions

* In Certified Wind Load region, indicated transoms must be installed in a separate opening or use approved engineering mulls



TUSCANY

LAMINATED DECORATIVE GLASS

Tuscany features a unique lamination that holds shattered glass together, maintaining security beautifully.



HIGH PERFORMANCE BENEFITS

Remarkable beauty and security at a great price. 99% UV blockage prevents fading of carpets and furniture.



FORCED ENTRY DETERRENT

All glass can be shattered after continuous impact, but these laminated decorative designs are break-through resistant to deter burglaries.

PRIVACY RATING



less privacy

more privacy



440TUS-1P

Tuscany glass is designed to deter burglaries. Unfortunately, entry systems with Tuscany glass are not ENERGY STAR® Certified.

612/613TUS** ☼ pg. 102



140TUS 440TUS† 140TUS



160TUS 350TUS 160TUS



240TUS



130TUS 430TUS†



230TUS 130TUS



430TUS† 130TUS

TUSCANY STYLE AVAILABILITY

	Doors					Sidelites			8' Doors	8' Sidelites
	440	350	240	430	230	160	140	130	430	130
Signet Mahogany Series	•			•			•	•		
Signet Cherry Series	•			•			•	•		
Signet Oak Series	•			•			•	•		
Signet Knotty Alder Series				•					•	
Signet Smooth Series	•					•	•			
Heritage Woodgrain Textured Fiberglass	•	•		•	•	•	•	•	•	•
Heritage Smooth Fiberglass	•	•		•	•	•	•	•	•	•
20-Gauge Woodgrain Textured Steel	•	•	•	•	•	○	○	○		
20-Gauge Smooth Steel	•	•	•	•	•	○	○	○	•	•
Price List Page Number	36	49	40	19	25	68	66	62	80	91

† For additional door panel styles see pg. 18 (for Signet®), pg. 20 (for Heritage™) or pg. 22 (for Legacy™)

** Requires an additional 4-week lead time

○ Steel sidelites are made from 24-Gauge steel

☼ Cannot be mulled with Heritage Fiberglass doors in Certified Wind Load regions



TWILIGHT

DECORATIVE GLASS

Twilight is a beautifully decorative silk-screened art. It's unique frosted glass adds to the warmth and privacy of your home.

PRIVACY RATING

1 2 3 4 5 6 7 **8** 9 10

less privacy

more privacy



LIFETIME LIMITED WARRANTY
Includes Glass Breakage & Seal Failure

430TWI-2P



All Full Wood Frame and Composite Frame Entry Systems using Twilight Glass are ENERGY STAR® Certified and some Steel L-Frame Entry Systems using Twilight Glass are ENERGY STAR Certified. See the ENERGY STAR section of our website for energy ratings on specific styles.



160TWI 350TWI 160TWI

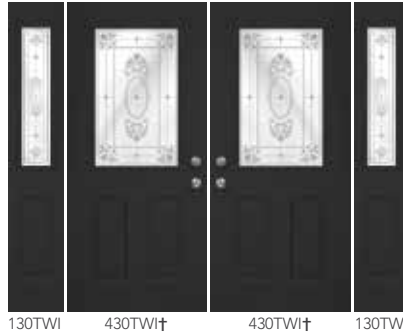

130TWI 430TWI† 430TWI† 130TWI

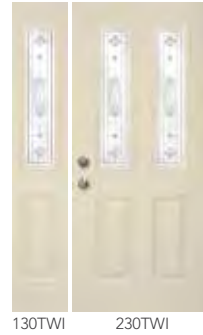

130TWI 230TWI



400TWI†



160TWI 110TWI 160TWI

TWILIGHT STYLE AVAILABILITY

	Doors					Sidelites	
	350	430	230	400	110	160	130
Signet Mahogany Series		●					●
Signet Cherry Series		●					●
Signet Oak Series		●					●
Signet Knotty Alder Series		●				●	
Heritage Woodgrain Textured Fiberglass	●	●	●	●		●	●
Heritage Smooth Fiberglass	●	●	●	●		●	●
20-Gauge Woodgrain Textured Steel	●	●	●	●		○	○
20-Gauge Smooth Steel	●	●	●	●	●	○	○
Price List Page Number	50	20	25	9	17	68	63

† For additional door panel styles see pg. 14 (for Embarq®), pg. 18 (for Signet®), pg. 20 (for Heritage™) or pg. 22 (for Legacy™)
 ○ Steel sidelites are made from 24-Gauge steel

INSPIRATIONS™ ART GLASS FEATURES

DESIGNS:

The process begins with conceptual design. Our twelve beautiful Inspirations Art Glass styles originated from the imagination of our in-house designers.

RESIN BEAD:

The design pattern is created on our computer software, and sent to a CNC machine which applies a resin bead to the surface of the glass in one of our four stylish colors.

COLOR FILL:

The color fill truly brings the glass to life. Five distinct color palettes are offered empowering you to perfectly reflect the personality of you and your home. Our craftsmen hand-apply this color fill to your glass.

OUR GUARANTEE:

The resin bead and color fill are backed by our Lifetime Limited Warranty, and will not fade, blister or peel away from the glass.



INSPIRATIONS™ ART GLASS

Inspirations Art Glass allows you to do just what the name suggests, let your doors and windows reflect the inspiration of your imagination with your choice of design and color.

LIFETIME LIMITED WARRANTY
Includes Glass Breakage & Seal Failure



TO SEE MORE INSPIRATIONS:

Ask to see our Inspirations Art Glass brochure for available styles and color palettes, or use our ProVia iPad app to create custom color palettes and design your dream door.



**Visit the App Store to download
your free app today!**



CHINCHILLA (CHI)

PRIVACY RATING

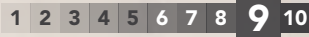

less privacy more privacy



TAFFETA (TAF)

PRIVACY RATING



less privacy more privacy



WATERFALL (WAT)

PRIVACY RATING

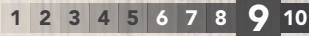

less privacy more privacy



GLUECHIP (GLC)

PRIVACY RATING

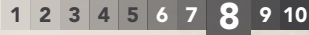

less privacy more privacy



OBSCURE PEBBLE (OBS)

PRIVACY RATING



less privacy more privacy



Privacy glass allows light to filter in, while keeping a high level of privacy.

LIFETIME LIMITED WARRANTY
Includes Glass Breakage & Seal Failure

PRIVACY STYLE AVAILABILITY

	Doors											Sidelites					8' Doors				8' Sidelites													
	460	440	449	439	437	430	243	240	239	230	112	114	115	116	420	419	400	110	770	160	140	130	139	120	460	440	430	437	114	115	116	160	140	130
Embarq / Signet Mahogany Series	•	•				•										•			•	•	•	•												
Embarq / Signet Cherry Series	•	•	•			•	•									•			•	•	•	•			*							*		
Embarq / Signet Oak Series	•	•				•	•									•			•	•	•	•												
Signet Fir Series															•				•	•				•										
Embarq / Signet Knotty Alder Series	•					•													•	•					*	*						*		
Signet Smooth Series	•	•																	•	•	•													
Heritage Woodgrain Textured Fiberglass	•	•	•			•	•			•					•	•	•		•	•	•	•			•	•						•	•	•
Heritage Smooth Fiberglass	•	•	•			•	•			•	•	•	•	•	•	•	•		•	•	•	•			•	•	•	•	•	•		•	•	•
20-Gauge Woodgrain Textured Steel	•	•	•			•	•	•		•					•	•	•		•	•	•	•	•	•										
20-Gauge Smooth Steel	•	•	•	•	•	•	•	•	•	•	•	•	•	•	•	•	•	•	•	•	•	•	•	•	•	•	•	•	•	•		•	•	•
Price List Page Number	47	38	43	30	28	22	33	42	31	27	54	55	55	55	16	13	10	17	77	69	66	63	65	61	89	87	82	83	90	90	90	95	94	92
Price List Page Number (for Embarq)	142	139	140			136	137								134				151	147	146	145												



 All entry systems with Privacy Glass can be ENERGY STAR® Certified depending on the glazing system you choose. This chart indicates which glazing system is required for ENERGY STAR certification, as well as availability.

Door Styles	Glazing Systems			
	TLK	TLA	DLA	DC
HALF-LITE OR LARGER 460, 449, 440, 437, 430, 439, 240, 239, 230, 112, 114, 115, 116	●	●	●	●
SMALLER THAN HALF-LITE 420, 419, 400, 243, 110	●	●	●	●

● ENERGY STAR Certified
Refer to pg. 25 for Glazing Systems information

Since Low-E glass has a slight color tint, it is recommended that sidelites are ordered with the same glazing system as the door.



† For additional door panel styles see pg. 14 (for Embarq™), pg. 18 (for Signet®), pg. 20 (for Heritage™) or pg. 22 (for Legacy™)
 ○ Steel sidelites are made from 24-Gauge steel
 § Also available in 10" width.
 * Embarq doors and sidelites are not available in 8' heights
 ● Not tested for Certified Wind Load region
 ⊕ Cannot be mullied with Heritage Fiberglass doors in Certified Wind Load regions
 ◆ Only available with Modern Flat Window Trim. Only available with 770 sidelite(s) or 160 sidelite(s) with Modern Flat Window Trim.

Note - Privacy glass is available in Simulated Divided Lites (see pg. 81) and External Grids (see pg 85).



An innovative design results in stacked blinds that take up the smallest of space at the top of the door glass when fully opened. Privacy channels on each side of the door glass eliminate light gaps when the blinds are closed, including street-light shadows or sunlight glare. (Note: Operator is always located on the right-hand side.)

INTERNAL BLINDS

460BLR-IGP

Internal Blinds are constructed with sturdy white aluminum and enclosed in tempered safety glass. Easy to clean; no more dusting of blinds. Internal Blinds are suitable for entry doors, sidelites and patio doors and carry a 10-Year Warranty.

Additional Light Control - BLR styles can also be raised and lowered completely.

Internal Blinds also available with optional Low-E
 Note: 160BLD-IGT, 160BLD-IGP, 160BLD-IGC, and 160BLD cannot be raised and lowered

INTERNAL BLINDS STYLE AVAILABILITY

	Doors				Sidelites		8' Doors
	460	440	430	230	160	130	430
Signet Mahogany Series							
Signet Cherry Series							
Signet Oak Series							
Signet Fir Series							
Signet Knotty Alder Series							
Heritage Woodgrain Textured Fiberglass	•	•	•	•	•	•	•
Heritage Smooth Fiberglass	•	•	•	•	•	•	•
20-Gauge Woodgrain Textured Steel	•	•	•		o	o	
20-Gauge Smooth Steel	•	•	•	•	o	o	•
Price List Page Number	48	38	22	27	69	64	80



All entry systems with Internal Blinds can be ENERGY STAR® Certified depending on the glazing system you choose. This chart indicates which glazing system is required for ENERGY STAR certification, as well as availability.

Door Styles	DLA	DC
INTERNAL BLINDS		
With Internal Grids	•	•
INTERNAL BLINDS		
Without Grids	•	•

• ENERGY STAR Certified
 Refer to pg. 25 for Glazing Systems information

Since Low-E glass has a slight color tint, it is recommended that sidelites are ordered with the same glazing system as the door.

WITH **TRADITIONAL** (COLONIAL) INTERNAL GRIDS



WITH **PRAIRIE** INTERNAL GRIDS



WITH **COTTAGE** INTERNAL GRIDS



BLINDS **WITHOUT** INTERNAL GRIDS

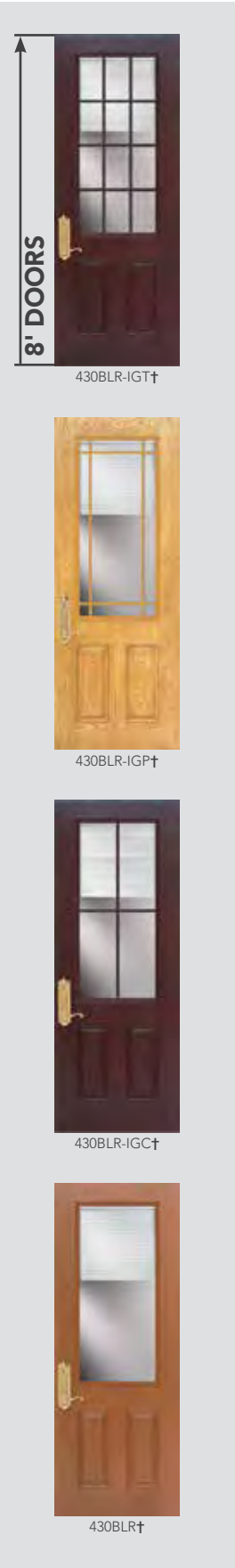

Internal Blinds

† For additional door panel styles see pg. 20 (for Heritage™) or pg. 22 (for Legacy™)
 o Steel sidelites are made from 24-Gauge steel

Note: 160BLD-IGT, 160BLD-IGP, 160BLD-IGC, and 160BLD cannot be raised and lowered

SIMULATED DIVIDED LITES

CRAFTSMAN

Only available for Signet Fir Series

CONTOURED

Available for all styles shown, except for Signet Fir Series

420DC-SDT-DS

Simulated Divided Lites (SDL) are reminiscent of old world craftsmanship when separate pieces of glass were mull together with wooden grids. We deliver that same stunning appearance through our high-tech stained fiberglass 1" wide x 1¹/₂" thick grids combined with the energy efficient qualities of our ComforTech glass packages.

LIFETIME LIMITED WARRANTY
Includes Glass Breakage & Seal Failure

SIMULATED DIVIDED LITES STYLE AVAILABILITY

	Doors						Sidelites				8' Doors			8' Sidelites
	460	440	449	430	420	419	160	140	130	120	440	430	437	140
Embarq / Signet Mahogany Series	•	•		•		•	•	•						
Embarq / Signet Cherry Series	•	•	•	•		•	•	•		*				*
Embarq / Signet Oak Series	•	•		•		•	•	•						
Signet Fir Series					•		•		•					
Embarq / Signet Knotty Alder Series	•			•			•			*	*			*
Signet Smooth Series	•	•					•	•						
Heritage Woodgrain Textured Fiberglass ▲	•	•		•			•	•	•				•	
Heritage Smooth Fiberglass ▲	•	•					•	•	•				•	
20-Gauge Woodgrain Textured Steel ▲	•	•		•			•	•	•				•	
20-Gauge Smooth Steel ▲	•	•		•			•	•	•				•	
Price List Page Number	48	38	43	23	16	13	69	67	64	61	87	80	81	94
Price List Page Number (for Embarq)	142	139	140	136		134	147	146	145					

† For additional door panel styles see pg. 14 (for Embarq®) or pg. 18 (for Signet®)

* Embarq doors and sidelites are not available in 8' heights

▲ Requires plugless trim



All entry systems with Simulated Divided Lites can be ENERGY STAR® Certified depending on the glazing system you choose. This chart indicates which glazing system is required for ENERGY STAR certification, as well as availability.

Door Styles	Glazing Systems			
	TLK	TLA	DLA	DC
HALF-LITE OR LARGER				
460, 440, 449, 430, 437			•	•
SMALLER THAN HALF-LITE				
420, 419			•	•

• ENERGY STAR Certified

Refer to pg. 25 for Glazing Systems information

Since Low-E glass has a slight color tint, it is recommended that sidelites are ordered with the same glazing system as the door.

612/613DC-SDT pg. 104



Simulated Divided Lites



616DC-SDT pg. 104



Note - All doors and sidelites with SDL's are available with privacy glass.
 Note - SDL's match stain or paint of door.



INTERNAL GRID OPTIONS

Note: Pencil Grids are not available in Prairie Grids on some indicated doors and transoms

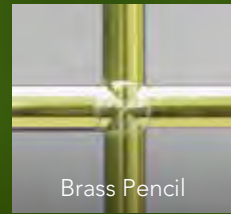

Brass Pencil

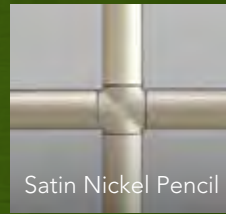

Satin Nickel Pencil

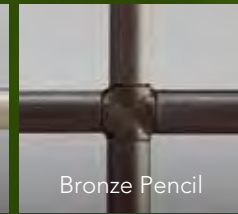

Bronze Pencil



Painted Contoured

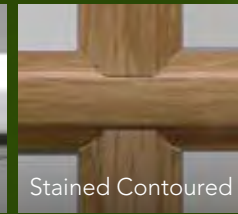

Stained Contoured

INTERNAL GRIDS

CONTOURED GRID COLORS AND STAINS

Snow Mist	Café Cream	Sandpiper Beige	Sandstone	Clay	Forest Green	Mountain Berry	Rustic Bronze
Tudor Brown	Coal Black†	Honey Wheat† & Light Oak†	Oak†	American Cherry† & Cherry†			

TWO-TONE CONTOURED GRIDS

Snow Mist	Snow Mist	Snow Mist	Snow Mist	Snow Mist	Snow Mist	Snow Mist	Snow Mist
Café Cream	Sandpiper Beige	Sandstone	Forest Green	Mountain Berry	Coal Black†	Honey Wheat† & Light Oak†	Oak†
Snow Mist	Snow Mist	Snow Mist	Sandpiper Beige	Sandpiper Beige	Sandpiper Beige	Sandpiper Beige	Sandpiper Beige
Almond† & Dark Oak†	American Cherry† & Cherry†	Toffee† & Traditional Cherry†	Honey Wheat† & Light Oak†	Oak†	Almond† & Dark Oak†	American Cherry† & Cherry†	Toffee† & Traditional Cherry†
Sandstone	Sandstone	Sandstone	Sandstone	Sandstone			
Honey Wheat† & Light Oak†	Oak†	Almond† & Dark Oak†	American Cherry† & Cherry†	Toffee† & Traditional Cherry†			

† Not available in 400DC-IG

INTERNAL GRIDS STYLE AVAILABILITY

	Doors										Sidelites					8' Doors				8' Sidelites			
	460	449	440	437	430	240	230	420	419	400	770	160	140	130	120	460	440	430	437	160	140	130	770
Embarq / Signet Mahogany Series	•	•	•					•			•	•	•	•									
Embarq / Signet Cherry Series	•	•	•	•	•			•			•	•	•	•		*				*		*	
Embarq / Signet Oak Series	•	•	•					•			•	•	•	•									
Signet Fir Series								•			•	•		•									
Embarq / Signet Knotty Alder Series	•		•								•	•				*	*			*	*		
Signet Smooth Series	•	•									•	•	•										
Heritage Textured Fiberglass	•	•	•	•	•	•	•	•	•	•	•	•	•	•	•	•	•			•	•	•	•
Heritage Smooth Fiberglass	•	•	•	•	•	•	•	•	•	•	•	•	•	•	•	•	•			•	•	•	•
20-Gauge Woodgrain Textured Steel	•	•	•	•	•	•	•	•	•	•	•	•	•	•	•								
20-Gauge Smooth Steel	•	•	•	•	•	•	•	•	•	•	•	•	•	•	•	•	•			•	•	•	•
Price List Page Number	48	43	38	28	23	42	27	16	13	10	77	69	67	64	61	89	87	82	83	95	94	92	96
Price List Page Number (Embarq)	142	140	139		136				134		151	147	146	145									

* Embarq doors and sidelites are not available in 8' heights



All entry systems with Internal Grids can be ENERGY STAR® Certified depending on the glazing system you choose. This chart indicates which glazing system is required for ENERGY STAR certification, as well as availability.

Door Styles	Glazing Systems		
	TLA	DLA	DC
HALF-LITE OR LARGER			
460, 440, 430, 240, 230	•	•	•
449, 437		•	•
SMALLER THAN HALF-LITE			
420, 419, 400	•	•	•

• ENERGY STAR Certified
Refer to pg. 25 for Glazing Systems information

Since Low-E glass has a slight color tint, it is recommended that sidelites are ordered with the same glazing system as the door.

TRADITIONAL (COLONIAL) INTERNAL GRIDS



460DC-IGT 160DC-IGT 449DC-IGT† 770DC-IGT§ 440DC-IGT† 140DC-IGT 437DC-IGT† 430DC-IGT† 130DC-IGT 240DC-IGT 230DC-IGT 420DC-IGT-DS† 120DC-IGT 420DC-IG6-DS† 120DC-IG4 400DC-IGT†

PRAIRIE INTERNAL GRIDS



460DC-IGP N/A in Pencil Grids 160DC-IGP N/A in Pencil Grids 449DC-IGP† N/A in Pencil Grids 770DC-IGP§ N/A in Pencil Grids 440DC-IGP† N/A in Pencil Grids 140DC-IGP N/A in Pencil Grids 437DC-IGP† N/A in Pencil Grids 430DC-IGP† 130DC-IGP N/A in Pencil Grids 240DC-IGP 230DC-IGP 420DC-IGP-DS†

COTTAGE INTERNAL GRIDS

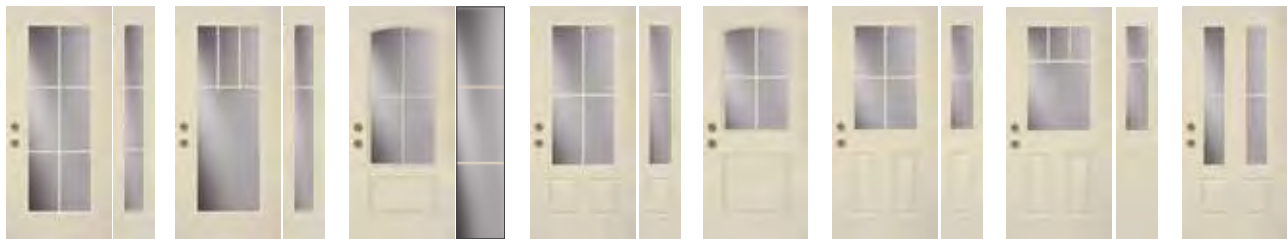

460DC-IGC 160DC-IGC 460DC-IGC-TS 160DC-IGC-TS 449DC-IGC† 770DC-IGC§ 440DC-IGC† 140DC-IGC 437DC-IGC† 430DC-IGC† 130DC-IGC 430DC-IGC-TS† 130DC-IGC-TS 240DC-IGC

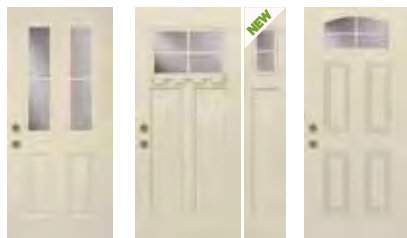

230DC-IGC 420DC-IGC-DS† 120DC-IGC 419DC-IGC†

TRANSOMS



512/513DC-IGS§ pg. 101 Not available in Pencil Grids 612/613DC-IGS§ pg. 103 Not available in Pencil Grids 532DC-IGS* pg. 105 616DC-IGT§ pg. 104 516DC-IGS* pg. 105 612/613DC-IGT§ pg. 103 712/713DC-IGS**§ pg. 100 Not available in Pencil Grids 616DC-IGP§ pg. 104



460DC-IGT 160DC-IGT 460DC-IGC 160DC-IGC 440DC-IGT† 140DC-IGT 440DC-IGC† 140DC-IGC 440DC-IGP† 140DC-IGP N/A in Pencil Grids 430DC-IGT† 130DC-IGT 430DC-IGP† 130DC-IGP N/A in Pencil Grids

430DC-IGC† 130DC-IGC 437DC-IGT† 770DC-IGT§ 437DC-IGC† 770DC-IGC§ 437DC-IGP† N/A in Pencil Grids

- § Also available in 10" width.
- ** Requires an additional 4-week lead time
- † For additional door panel styles see pg. 14 (for Embarq™), pg. 18 (for Signet®), pg. 20 (for Heritage™) or pg. 22 (for Legacy™)
- o Steel sidelites are made from 24-Gauge steel
- Cannot be mullied with Heritage Fiberglass doors in Certified Wind Load regions
- * In Certified Wind Load region, indicated transoms must be installed in a separate opening or use approved engineering mulls

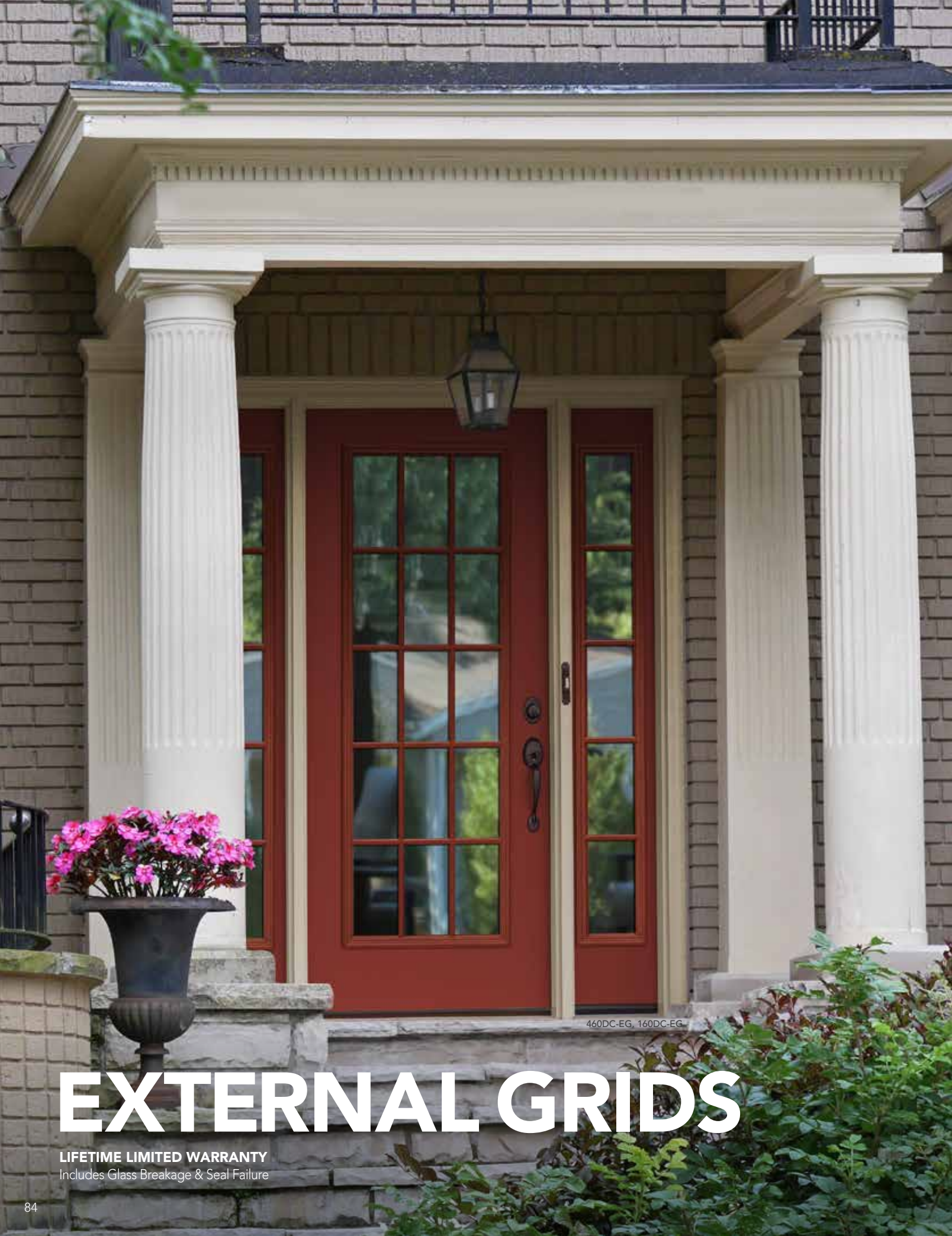

460DC-EG, 160DC-EG

EXTERNAL GRIDS

LIFETIME LIMITED WARRANTY
Includes Glass Breakage & Seal Failure



External grids will match the door's paint or stain color.

Note: All doors with external grids (except for 410 style) are available with privacy glass.

EXTERNAL GRID STYLE AVAILABILITY

	Doors						Sidelites	
	460	430	439	230	410	400	160	130
Signet Mahogany Series								
Signet Cherry Series								
Signet Oak Series								
Signet Knotty Alder Series								
Signet Smooth Series								
Heritage Woodgrain Textured Fiberglass	●	●	●	●	●	●	●	●
Heritage Smooth Fiberglass	●	●	●	●	●	●	●	●
20-Gauge Woodgrain Textured Steel	●	●	●		●	●	○	○
20-Gauge Smooth Steel	●	●	●	●	●	●	○	○
Price List Page Number	48	23	30	27	54	10	69	64

† For additional door panel styles see pg. 20 (for Heritage™) or pg. 22 (for Legacy™)
 Δ Not available in 1" warm edge. Also, window trim screw plugs are not available for this door style.
 ○ Steel sidelites are made from 24-Gauge steel



All entry systems with External Grids can be ENERGY STAR® Certified depending on the glazing system you choose. This chart indicates which glazing system is required for ENERGY STAR certification, as well as availability.

Door Styles	Glazing Systems			
	TLK	TLA	DLA	DC
HALF-LITE OR LARGER				
460, 430, 439, 230	●	●	●	●
SMALLER THAN HALF-LITE				
410				●
400	●	●	●	●

● ENERGY STAR Certified
 Refer to pg. 25 for Glazing Systems information

Since Low-E glass has a slight color tint, it is recommended that sidelites are ordered with the same glazing system as the door.

CLEAR GLASS

460DC, 770DC

Clear Glass is appropriate on every entry of your home and can still be energy efficient.

LIFETIME LIMITED WARRANTY

Includes Glass Breakage & Seal Failure

Door Styles	Glazing Systems			
	TLK	TLA	DLA	DC
HALF-LITE OR LARGER				
460, 449, 440, 439, 437, 430, 350, 240, 239, 230, 150, 112, 114, 115, 116	●	●	●	●
SMALLER THAN HALF-LITE				
420, 419, 400, 243, 110	●	●	●	●
306, 206, 131, 101, 100				●



All entry systems with Clear Glass can be ENERGY STAR® Certified depending on the glazing system you choose. This chart indicates which glazing system is required for ENERGY STAR certification, as well as availability.

● ENERGY STAR Certified
Refer to pg. 25 for Glazing Systems information

Since Low-E glass has a slight color tint, it is recommended that sidelites are ordered with the same glazing system as the door.

CLEAR GLASS STYLE AVAILABILITY

	Doors																		Sidelites						8' Doors						8' Sidelites																
	460	440	449	439	437	430	430-F	350	243	240	239	230	150	112	114	115	116	420	419	400	306	206	131	110	101	100	770	160	140	139	130	120	106	460	440	430	437	150	114	115	116	160	140	130	770		
Embarq / Signet Mahogany Series	●	●											●														●	●	●		●			●	●	●	●					●	●	●			
Embarq / Signet Cherry Series	●	●	●			●	●	●						●								●					●	●	●		●							●	●			●	●	●			
Embarq / Signet Oak Series	●	●				●			●					●													●	●	●		●							●	●			●	●	●			
Signet Fir Series																			●								●	●																			
Embarq / Signet Knotty Alder Series	●					●																					●	●										●	●			●	●	●			
Signet Smooth Series	●	●											●														●	●	●																		
Heritage Textured Fiberglass	●	●	●	●	●	●	●	●	●	●	●	●	●	●	●	●	●	●	●	●	●	●	●	●	●	●	●	●	●	●	●	●	●	●	●			●	●			●	●	●			
Heritage Smooth Fiberglass	●	●	●	●	●	●	●	●	●	●	●	●	●	●	●	●	●	●	●	●	●	●	●	●	●	●	●	●	●	●	●	●	●	●	●			●	●			●	●	●			
20-Gauge Woodgrain Textured Steel	●	●	●	●	●	●	●	●	●	●	●	●	●	●	●	●	●	●	●	●	●	●	●	●	●	●	●	○	○	○	○	○	○														
20-Gauge Smooth Steel	●	●	●	●	●	●	●	●	●	●	●	●	●	●	●	●	●	●	●	●	●	●	●	●	●	●	●	○	○	○	○	○	○	●	●			●	●			●	●	●			
Price List Page Number	48	38	43	30	29	22	57	51	34	42	31	27	53	54	55	55	16	13	10	56	54	56	17	56	56	77	69	67	65	63	61	72	89	87	82	83	85	90	90	90	95	94	92	96			
Price List Page Number (Embarq)	142	139	140			136	136	137					144						134							151	147	146				145															

● Not tested for Certified Wind Load regions

TRANSOMS



460DC 160DC 440DC† 140DC



532DC* pg. 105



612/613DC⊕ pg. 100



512/513DC⊕ pg. 101



516DC* pg. 105



616DC⊕ pg. 104



712/713DC**⊕ pg. 100

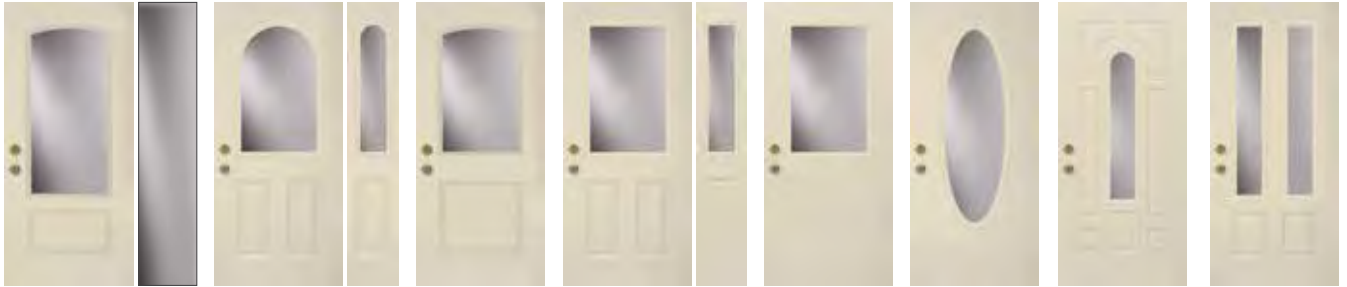

449DC† 770DC⊕§ 439DC† 139DC 437DC† 430DC† 130DC 430DC-F† 350DC 243DC 240DC

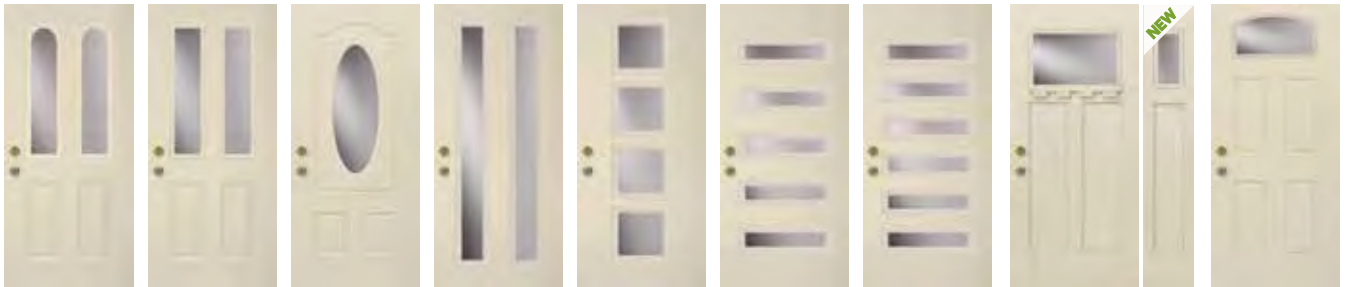

239DC 230DC 150DC† 112DC◆ 114DC◆ 115DC◆ 116DC◆ 420DC-D5† 120DC 419DC†

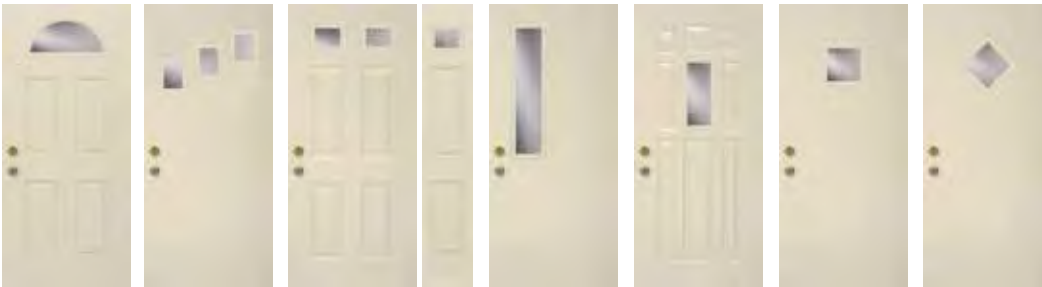

400DC† 306DC 206DC 106DC 131DC 110DC 101DC 100DC



8' DOORS

460DC 160DC

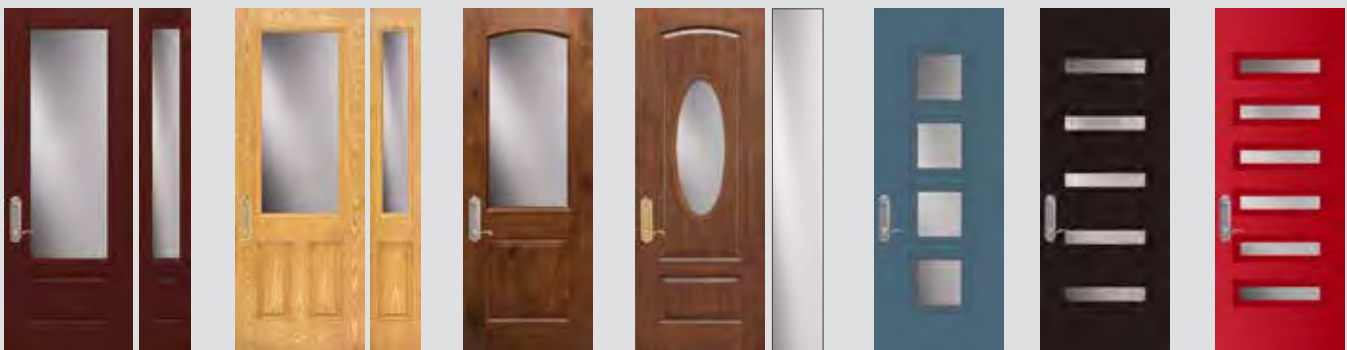

440DC† 140DC 430DC† 130DC 437DC† 150DC-1P 770DC§ 114DC◆ 115DC◆ 116DC◆

§ Also available in 10" width.

** Requires an additional 4-week lead time

* Embarq doors and sidelites are not available in 8' heights

† For additional door panel styles see pg. 14 (for Embarq®), pg. 18 (for Signet®), pg. 20 (for Heritage™) or pg. 22 (for Legacy™)

○ Steel sidelites are made from 24-Gauge steel

⊕ Cannot be mullied with Heritage Fiberglass doors in Certified Wind Load regions

* In Certified Wind Load region, indicated transoms must be installed in a separate opening or use approved engineering mulls

◆ Only available with Modern Flat Window Trim. Only available with 770 sidelite(s) or 160 sidelite(s) with Modern Flat Window Trim.

Clear Glass



003, 140BRC

Doors Without Glass will fill your needs beautifully when privacy is needed.

LIFETIME LIMITED WARRANTY
Includes Glass Breakage & Seal Failure

DOORS WITHOUT GLASS STYLE AVAILABILITY

	Doors														8' Doors							
	009	008P	008	006C	006	004	003M	003	003C	002C(P)-449	002	002C(P)-437	002-440	002P-440	001	001	002W(P)	002C(P)-449	002C(P)-437	002	006	008P
Embarq / Signet Mahogany Series					•			•														
Embarq / Signet Cherry Series	•									•				•		*	•*		*			
Embarq / Signet Oak Series	•												•	•								
Signet Fir Series									•													
Embarq / Signet Knotty Alder Series														•						*		
Signet Smooth Series								•					•									
Heritage Woodgrain Textured Fiberglass	•		•	•	•	•				•					•						•	•
Heritage Smooth Fiberglass	•			•	•					•					•							•
20-Gauge Woodgrain Textured Steel					•										•							
20-Gauge Smooth Steel	•	•						•	•			•	•		•							•
Price List Page Number	7	7	7	7	6	6	6	6	6	5	5	5	5	57	78	78	78	78	78	78	78	78
Price List Page Number (for Embarq)	132				132					132				132	132							

• Not tested for Certified Wind Load region
 ◆ Only available in 42" x 96" size
 * Embarq doors and sidelites are not available in 8' heights



All Entry Systems Without Glass are ENERGY STAR® Certified.



009



008P



008



006C



006



004

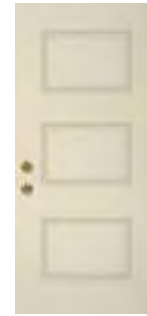

003M



003



003C



002C-449



002CP-449



002



002C-437



002CP-437



002-440



002P-440



001

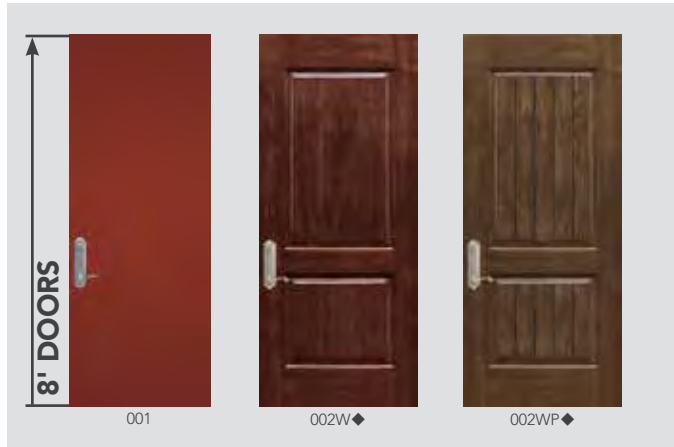

001

002W◆

002WP◆

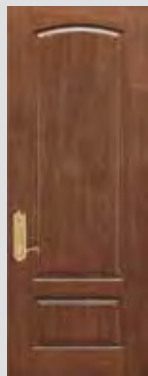

002C-449

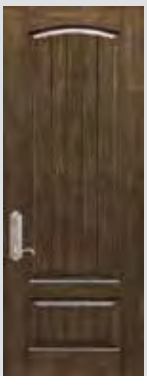

002CP-449

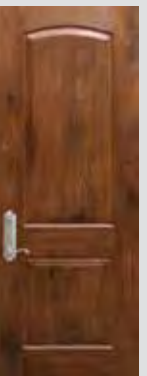

002C-437

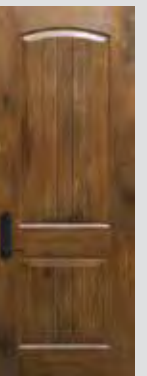

002CP-437

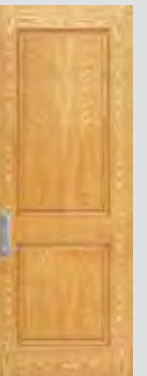

002

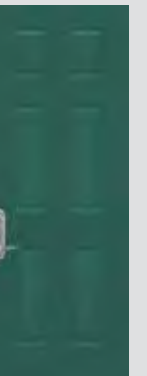

006



008P

Doors Without Glass

NEW



001-INS3-HN



INSCRIBED DOORS

Elegant and refined to complement an entranceway. Each design is engraved into a Signet Cherry fiberglass panel showcasing true richness of color and sophistication. Also available with three stainless steel inlay models.

LIFETIME LIMITED WARRANTY

INSCRIBED STYLES (Only available in flush Signet® cherry doors.)



001-INS3C



001-INS3-HN

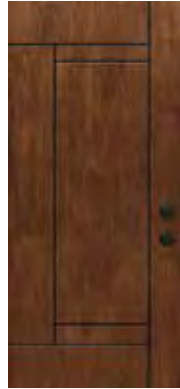

001-INS6



001-INS5

STAINLESS STEEL INLAY STYLES (Only available in flush Signet® cherry doors.)



001-INL4



001-INL4S



001-INL6

AVAILABLE COLORS

CHERRY STAINS

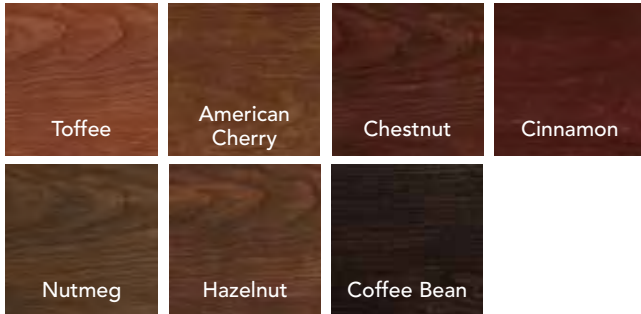

NEW



420DC-SDT-DS

EMBARQ™ & SIGNET® GLAZED FINISHES

Distinctive beauty achieved through a creative hand-applied finish giving each door a unique aged look.

10-YEAR FINISH WARRANTY*
Embarq® and Signet® Fiberglass

* Warranty time period may be limited in extreme exposure applications. See warranty for details.

**AVAILABLE
COLORS**

Shown on Signet®
Fir Series Doors



Rustic Sage

Dutch Gray

Winter Rain

Harbor Mist

Natural Leather

Glazed Finishes

Glazed Finishes are available in all Signet fiberglass styles (shown on pg. 18) and Embarq styles (shown on pg. 14). Below are a few sample styles.



002C- 437
Knotty Alder Series
Shown in Rustic Sage



003
Mahogany Series
Shown in Dutch Gray



002- 440
Cherry Series
Shown in Winter Rain



003
Mahogany Series
Shown in Harbor Mist



008P
Oak Series
Shown in Natural Leather

Always refer to our Glazed Finish Selector for accurate color representation.

EMBARQ® & SIGNET® FINISHES

Applied with care, by professionals. If you buy an entry system and finish it yourself, chances are it's the first door you've ever painted or stained. At ProVia®, stains are hand-applied by professional craftsmen, many who have been perfecting their work for years.

10-YEAR FINISH WARRANTY*
Embarq and Signet Fiberglass



SIGNET SERIES



MAHOGANY SERIES



CHERRY SERIES



OAK SERIES



KNOTTY ALDER SERIES



FIR SERIES
Only available on Signet 003C,
420, 420-DS & 160



SMOOTH
SERIES
Only available on Signet
with paint colors

* Warranty time period may be limited in extreme exposure applications. See warranty for details.

EMBARQ AND SIGNET STAINS

DURAFUSE™ STAIN FINISHING SYSTEM



CHERRY AND MAHOGANY STAINS

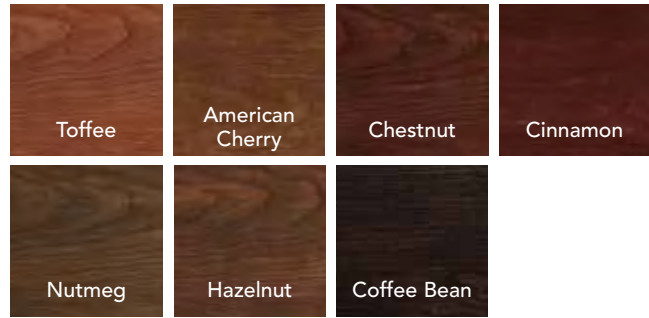

OAK, KNOTTY ALDER AND FIR[‡] STAINS

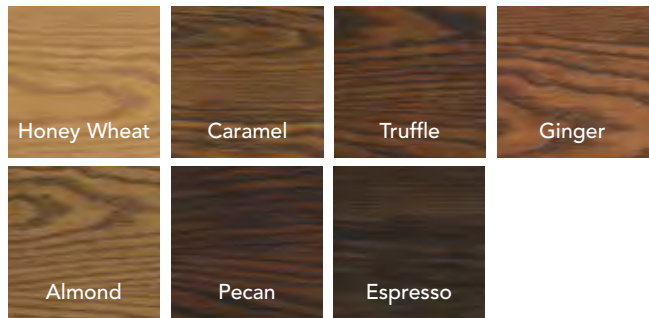

Always refer to our color selector for accurate color representation.
[‡] Embarq doors are not available in Fir Series

Embarq/Signet Finishes

EMBARQ AND SIGNET PAINTS

DURAFUSE™ PAINT FINISHING SYSTEM

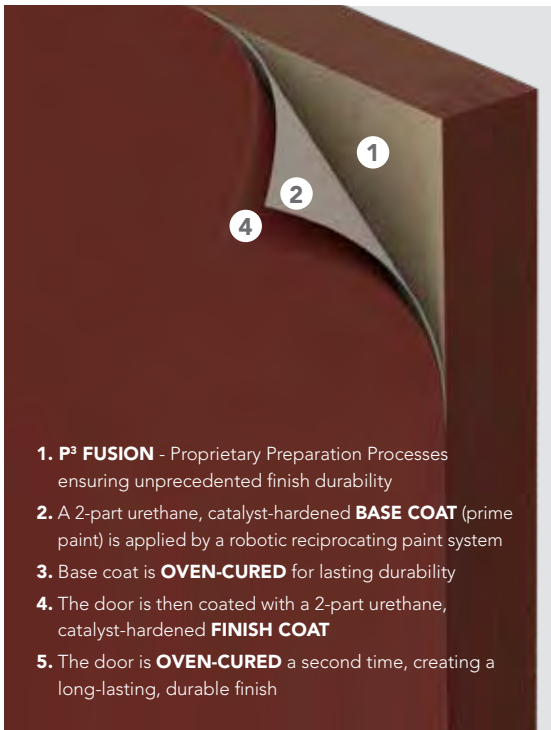

PAINT COLORS



Always refer to our color selector for accurate color representation.

† Limited Colors. Available on entry doors and storm doors.
 Matching cladding and caulking not available.

HERITAGE™ FIBERGLASS FINISHES

Applied with care, by professionals. If you buy an entry system and finish it yourself, chances are it's the first door you've ever painted or stained. At ProVia®, stains are hand-applied by professional craftsmen, many who have been perfecting their work for years.

7-YEAR FINISH WARRANTY*
Heritage Fiberglass



HERITAGE SKIN OPTIONS



OAK GRAIN PATTERN

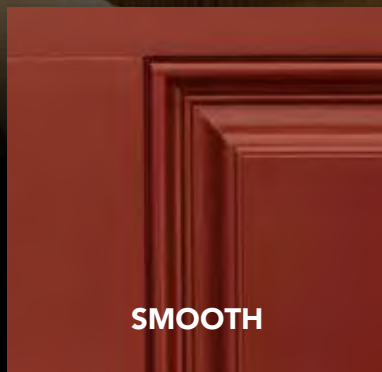

SMOOTH

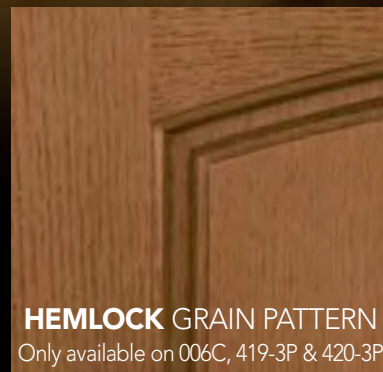

HEMLOCK GRAIN PATTERN
Only available on 006C, 419-3P & 420-3P

* Warranty time period may be limited in extreme exposure applications. See warranty for details.

HERITAGE STAINS

5-STEP STAIN FINISHING SYSTEM



HERITAGE STAINS

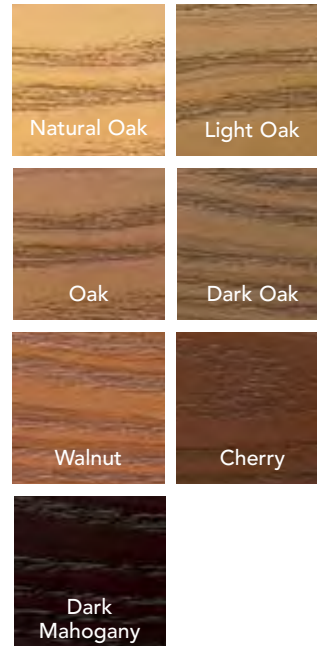

Always refer to our color selector for accurate color representation.

HERITAGE PAINTS

4-STEP PAINT FINISHING SYSTEM



PAINT COLORS



Always refer to our color selector for accurate color representation.

† Limited Colors. Available on entry doors and storm doors. Matching cladding and caulking not available.

LEGACY™ STEEL FINISHES

We do the finishing, so you don't have to.

You wouldn't try to paint one of these yourself, so why should it be any different when it comes to staining or painting your entry door?

7-YEAR FINISH WARRANTY*

Legacy Steel



LEGACY SKIN OPTIONS

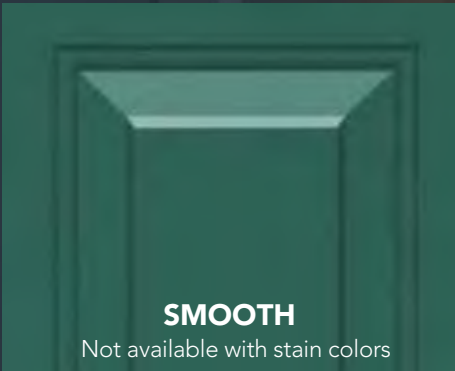

SMOOTH

Not available with stain colors

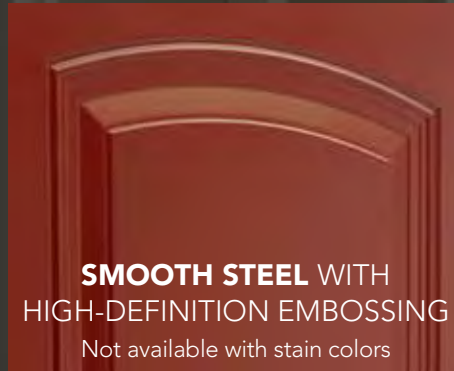

SMOOTH STEEL WITH HIGH-DEFINITION EMBOSSING

Not available with stain colors



WOODGRAIN TEXTURED

* Warranty time period may be limited in extreme exposure applications. See warranty for details.

- Embossed texture provides a traditional panel wood door look
- Provides deep shadow lines accentuating the character of the door's design
- Rich contouring adds depth and artistic character
- Only available in 20-gauge steel in styles with ❖ symbol shown on pg. 22

LEGACY STAINS

6-STEP STAIN FINISHING SYSTEM

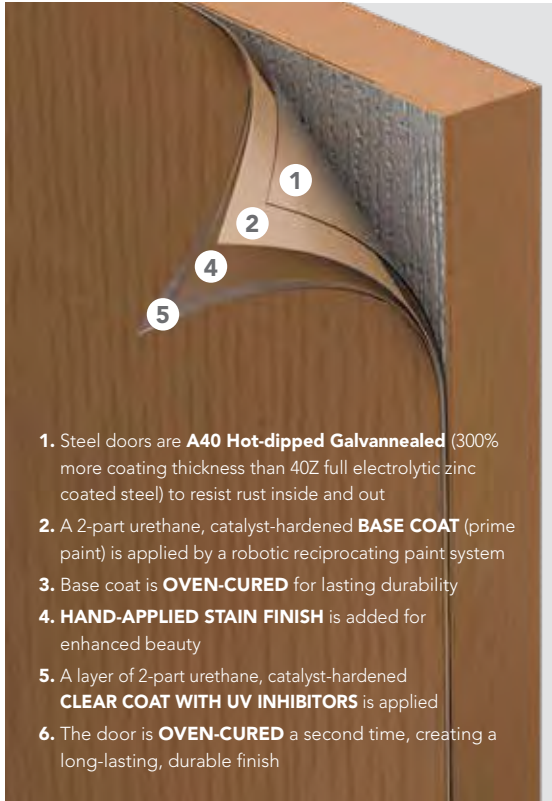

LEGACY STAINS

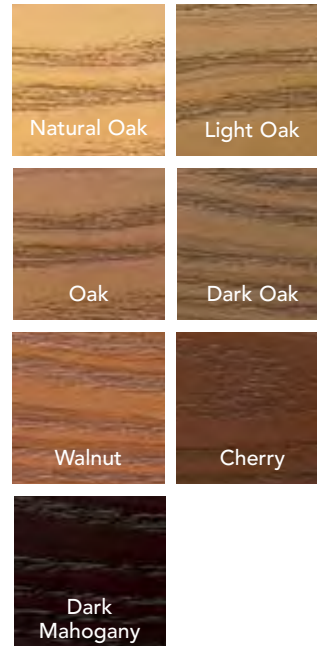

Always refer to our color selector for accurate color representation.

LEGACY PAINTS

5-STEP PAINT FINISHING SYSTEM

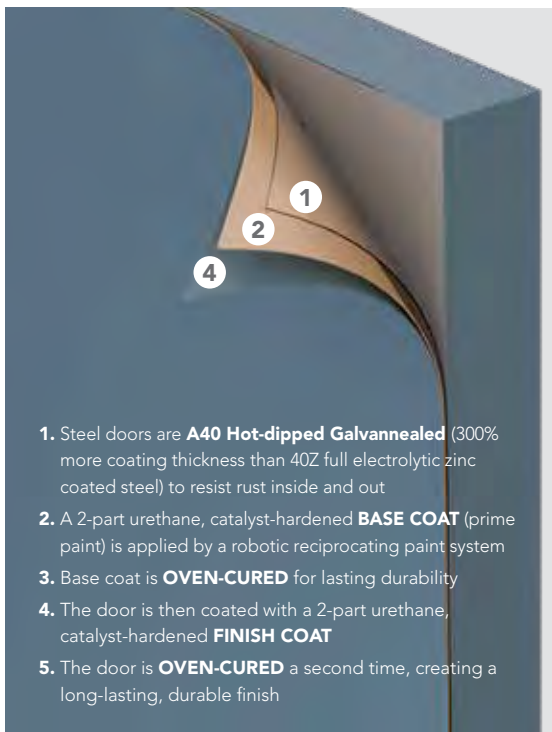

PAINT COLORS



Always refer to our color selector for accurate color representation.

† Limited Colors. Available on entry doors and storm doors. Matching cladding and caulking not available.

TRILENNIUM[®] MULTI-POINT

HARDWARE

The Trilennium Multi-Point locking system provides more than just security. It offers homeowners better door closure and sealing than a single point lock.

- Three 1" deadbolts latch with deadbolt throw
- Deadbolts include anti-saw hardened steel pin.
- A solid I-beam runs the full length of the lock, and increases the strength and precision of the lock.
- Latch and deadbolt release with a single downward movement.



Top and bottom latch design allows for door misalignment and $\frac{3}{16}$ " pull-in when deadbolted.

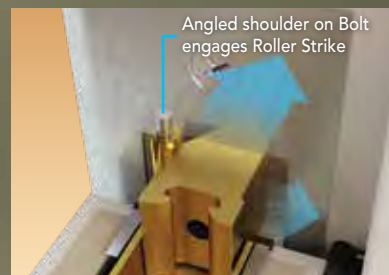
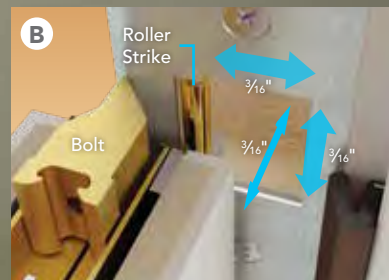

ECLIPSE (Not available in Black Finish)



Trilennium hardware is required on all 8' Signet® and Heritage™ fiberglass doors. Optional on all other fiberglass doors.

Also available on all 20-gauge Legacy steel doors.

NOT available on Steel L-Frames

Trilennium hardware has a 10-Year warranty on materials and workmanship.

Trilennium hardware is NOT available on French Doors in Certified Wind Load or Impact Shield regions.

PINNACLE (Not available in Black Finish)



**TRILENNIUM
HARDWARE IS AVAILABLE
IN THESE FINISHES**

- Lifetime Bright Brass
- Lifetime Satin Nickel
- Lifetime Flat Bronze*
- Lifetime Black*

WESTCOTT (Not available in Bright Brass Finish)



* Flat Bronze does not coordinate with Aged Bronze accessories. NEW Black finish is a closer match to Aged Bronze accessories.



Lifetime finish warranty time period is limited to five years if product is installed in an Impact Shield region.

NEW

HOPPE® MULTI-POINT

HARDWARE

Hoppe Multi-Point hardware offers the additional security of four points of latching when the door is locked, and the easy operation of one point of latching when the door is unlocked.

- Stainless Steel and other non-corrosive components.
- Anti-Back Drive prevents locking points from disengaging from the outside for added security.
- Latch Blocker on inactive systems will not allow multipoint activation until inactive system is activated.
- Lock Out Feature on interior system allows for multipoint activation from the exterior of the door by lifting handle.
- Backplate and cylinder housing are forged into one piece for improved appearance and easier installation.
- Simultaneous retraction feature enables all locking points to be retracted by pushing down on the inside handle.

**HOPPE
HARDWARE IS
AVAILABLE IN THESE
FINISHES**

Lifetime Bright Brass

Lifetime Satin Nickel

(Hoppe hardware is NOT tested for Certified Wind Load or Impact Shield regions)

EXTERIOR STYLES



New Orleans Contemporary Arch



New Orleans Classic Arch

INTERIOR STYLES



New Orleans Contemporary Arch



New Orleans Classic Arch

MULTI-POINT LOCKING

(Lock body faceplate is only available in stainless steel)

A
Three Point Deadbolt lock is engaged by lifting handle upward

B
Handleset latch

TO LOCK:
Step 1: Turn thumbturn ¼ turn counterclockwise

Step 2: Lift handle upward

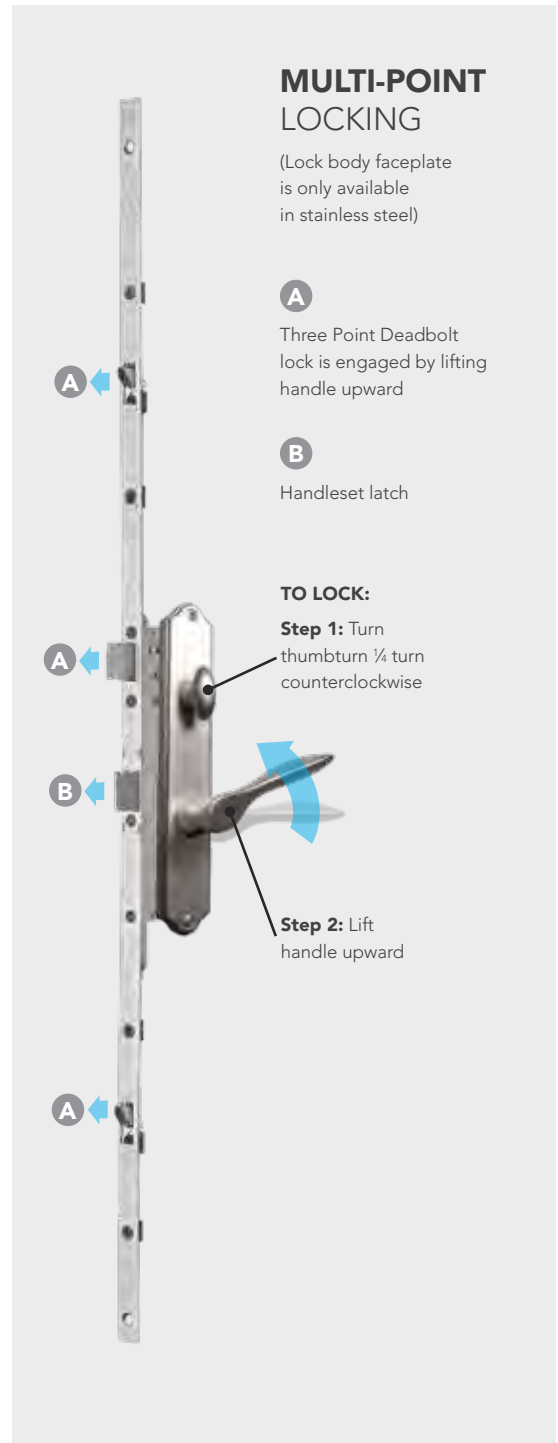



EMTEK[®] MORTISE

HARDWARE

EMTEK's Mortise hardware features the added advantages and options that come with push-button controls.

- Push-button passage controls
For more passage and locking options
- Heavy-duty Forged Brass Construction - *For long lasting beauty*
- Solid Brass Nose Bolts on Latches - *For dependable use*
- Lifetime Mechanical Warranty
Our guarantee of value
- Lifetime Anti-tarnish Finish
Warranty - Beauty for life

Push button passage controls provide added security and peace of mind. When the upper button is pressed in, the mortise lock is only accessible by using a key.

To activate the Passage Function, push in the lower button. This will allow you to access the thumb latch without a key.

Note: As long as the Passage Function is NOT engaged, the door will lock automatically when latched, and will not allow entry without a key.

EMTEK MORTISE HARDWARE IS AVAILABLE IN THESE FINISHES

Lifetime Bright Brass

Lifetime Satin Nickel

Lifetime Oil Rubbed Bronze

(EMTEK Mortise hardware is NOT tested for Certified Wind Load or Impact Shield regions)

(EMTEK Mortise hardware is only available for Signet Fiberglass and 20-gauge steel doors)

EXTERIOR STYLES



Craftsman*



Salem



Mills*



Albany

INTERIOR STYLES



Oval Beaded Egg (Shown on Salem)



Hammered Lever (Shown on Craftsman*)



Coventry Lever (Shown on Salem)



Square Knob (Shown on Mills*)



Cortina Lever (Shown on Albany)

EXTERIOR / INTERIOR AVAILABLE COMBINATIONS

Exterior Handles	Interior Levers and Knobs				
	Oval Egg	Square Knob	Coventry Lever	Hammered Lever	Cortina Lever
Salem	•	•	•		
Mills*	•	•	•		
Craftsman*				•	
Albany					•

* Not available in Bright Brass Finish



EMTEK's unique Interconnect Device provides the security of a locking deadbolt while providing the means for a panic-proof exit. Turning the interior knob or lever simultaneously retracts both the deadbolt and passage latches.

- Heavy-duty Forged Brass Construction - *For long lasting beauty*
- Durable Springs *To prevent lever sag*
- Threaded Brass Tubes *Solid brass nose bolts on latches*
- Lifetime Mechanical Warranty *Our guarantee of value*
- Lifetime Anti-tarnish Finish Warranty - *Beauty for life*

EMTEK HARDWARE
IS AVAILABLE IN THESE
FINISHES

- Lifetime Bright Brass
- Lifetime Satin Nickel
- Lifetime Oil Rubbed Bronze

 Lifetime finish warranty time period is limited to five years if product is installed in an Impact Shield region.

EMTEK[®]
HARDWARE

EXTERIOR STYLES (Single Point Lock)



Melrose



Imperial



Ribbon &
Reed



Orleans



Marietta

MODERN RECTANGULAR (Two Point Lock)



Round
Knob*



Hanover
Lever*

Hardware

INTERIOR STYLES

(Any interior handle can be used with any exterior handle)



Egg
(Shown on
Melrose)



Egg
(Shown on
Marietta)



Cortina
(Shown on
Orleans)



Turino
(Shown on
Imperial and
Ribbon & Reed)



Round
Knob*



Hanover
Lever*

* Not available in Bright Brass finish



SCHLAGE® VINTAGE

HARDWARE

Schlage Vintage hardware offers you much more than just great looks. Look to Schlage for hardware that looks great and lasts.

- Solid Cast Brass
For long lasting beauty
- Maximum Security Deadbolt
For peace of mind
- Nickel Silver Pins and Keys
For smooth, reliable operation
- Heavy Duty Springs
For durable and "droop-free" levers
- Superior Parts and Design
Tested for over 400,000 cycles of operation
- Lifetime Mechanical Warranty
Our guarantee of value
- Lifetime Anti-tarnish Finish Warranty
Beauty for life

SCHLAGE VINTAGE HARDWARE IS AVAILABLE IN THESE FINISHES

Lifetime Bright Brass

Lifetime Satin Nickel

Lifetime Antique Brass

Lifetime Aged Bronze



Lifetime finish warranty time period is limited to five years if product is installed in an Impact Shield region.

Antique Brass finish is NOT available.

EXTERIOR STYLES



Addison*

Camelot

Plymouth

INTERIOR STYLES



Georgian

Accent

Flair

Accent/Addison*

* Not available in Bright Brass finish

NEW

BRINKS® PUSH PULL ROTATE

HARDWARE

Brinks' Home Security Push Pull Rotate Knobs and Levers are the easiest, most comfortable way to open a door. With just one finger, an elbow, or your hip, you can simply push or pull your way through a door. Great if you have your hands full or free!

**BRINKS
HARDWARE IS
AVAILABLE IN THESE
FINISHES**

10-Year Satin Nickel

10-Year Aged Bronze



PUSH IT



PULL IT



ROTATE IT



EXTERIOR STYLES



Anderson with
Brynne Deadbolot



Harper Lever with
Almarion Deadbolt



Stafford Knob with
Almarion Deadbolt



INTERIOR STYLES



Harper Lever with
Brynne Deadbolt



Harper Lever with
Almarion Deadbolt



Stafford Knob with
Almarion Deadbolt

EXTERIOR / INTERIOR AVAILABLE COMBINATIONS

Exterior Handles	Interior Levers and Knobs	
	Harper Lever	Stafford Knob
Anderson	•	
Harper	•	
Stafford		•



SCHLAGE® ELECTRONIC KEYPADS

Electronic locksets and deadbolts utilize Schlage's Innovative keyless access. It's convenient and is customizable to fit your security needs.

- Deadbolt is available with any Schlage entry hardware
- 9-volt battery included
- Lighted keypad
- Up to 19 user codes
- Easy to add or delete codes
- Lifetime Mechanical and 1-Year Electronics Warranty

SCHLAGE ELECTRONIC KEYPAD IS AVAILABLE IN THESE FINISHES

Lifetime Bright Brass

Lifetime Satin Nickel

Lifetime Antique Brass

Lifetime Aged Bronze



Lifetime finish warranty time period is limited to five years if product is installed in an Impact Shield region.

Antique Brass finish is NOT available.

SCHLAGE SENSE™ SMART DEADBOLT

When you pair your Schlage Sense™ deadbolt with the Schlage Sense™ app you can check your lock status anytime you like within Bluetooth® range, as well as add and delete codes—giving you the final say in who comes and goes, and when they do it. Even better, users with Apple TV® can enjoy these tasks remotely.



ELECTRONIC KEYPAD DEADBOLT



Exterior

Interior

ACCENT LEVER ELECTRONIC LOCKSET



Exterior

Interior



Camelot Trim

(Only available in Satin Nickel and Aged Bronze finish)



Century Trim

(Only available in Satin Nickel finish)



Introducing Nexia™ Home Intelligence. Now, no matter where you go, the front door is within reach. That's because Nexia Home Intelligence is more than a lockset. It's a brilliant new way to enhance your home's security, and your family's peace of mind.

On the surface, Nexia Home Intelligence looks like a keypad entry lock — and it is. But it also features technology that

allows you to use your smart phone or computer to remotely unlock your doors, monitor entry and change pass codes. You can even pair Nexia Home Intelligence with other household items like lights and appliances for additional security and convenience.

That's freedom. That's intelligence.
That's Nexia Home Intelligence.



Hardware

**ELECTRONIC NEXIA
KEYPAD DEADBOLT**

(Not available in Antique Brass finish)



**ACCENT LEVER
ELECTRONIC KEYPAD LOCKSET**

(Not available in Antique Brass finish)



Nexia Home Intelligence Bridge Starter Kit

Nexia Home Intelligence requires the purchase of a Starter Kit which includes the Light Module and the Wireless Bridge, plus a monthly subscription fee to enable remote access from your computer or smart phone over the internet. Go to www.nexiahome.com for more information on Nexia Home Intelligence or to view their other home automation solutions such as Indoor Cameras, Outdoor Cameras, Thermostats, Motion Sensors and Window & Door Sensors.



SCHLAGE® CLASSIC HARDWARE

Schlage Classic hardware can fill your needs when you desire something understated, yet beautiful and lasting. Choose from an assortment of finishes.

SCHLAGE CLASSIC HARDWARE FINISHES

Lifetime Bright Brass

Lifetime Satin Nickel

Lifetime Antique Brass

Lifetime Aged Bronze



Lifetime finish warranty time period is limited to five years if product is installed in an Impact Shield region.

Antique Brass finish is NOT available.

SCHLAGE CLASSIC DOOR LOCKSETS AND DEADBOLTS



Accent/Addison
Keyed Lockset*



Accent Keyed
Lockset



Exterior Interior
Georgian Key in
Knob Lockset



Flair Keyed
Lockset



Latitude Lever with Century
Trim Keyed Lockset §



Latitude Lever with Collins
Trim Keyed Lockset ‡



Addison Trim *



Century Trim §



Thumbturn 1"
Deadbolts



Maximum Security
Double Key
1" Deadbolt ◊
(interior view)



Interior Only 1-Sided
Thumbturn 1" Deadbolt ◊
(Only available in 20-Gauge
Steel or Signet Fiberglass)



Accent/Addison
Passage Latch*



Accent
Passage Latch



Latitude Lever with
Century Trim §



Latitude Lever
with Collins Trim ‡



Flair
Passage Latch



Georgian
Passage Latch

SCHLAGE PASSAGE LATCHES

◊ Interior Only 1-Sided Thumbturn Deadbolts on any door which is used for egress may be a safety hazard in times of emergency. Double Key Deadbolts on any door which is used for egress are a safety hazard in times of emergency.

* Not available in Bright Brass finish

‡ Only available in Satin Nickel finish

§ Only available in Satin Nickel and Aged Bronze finish

OPTIONAL ACCESSORIES

Sometimes the smallest things make the biggest difference. Our accessories add a lot to the look of your entry system.



Colonial Door Knocker



Classic Door Knocker



Classic Door Knocker/Viewer



Mail Slot or Magazine Slot*
(NOT tested for Certified Wind Load or Impact Shield regions)
(Doors with Mail Slot or Magazine Slot are not ENERGY STAR certified)



1/8" Peepsite**



Kick Plate

OPTIONAL DECORATIVE HINGES NOT tested for Impact Shield regions.

Also available in Satin Nickel & Oil Rubbed Bronze (Inswing only)

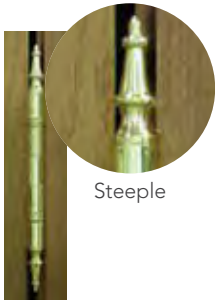

Steeple



Ball

ACCESSORIES FINISH AVAILABILITY 5-Year Mechanical Warranty

Accessories	Lifetime Finish			5-Year Finish		No Finish Warranty	Impact Shield 5-Year Finish
	Bright Brass	Satin Nickel	Aged Bronze	Bright Brass	Antique Brass	Oil Rubbed Bronze	Bright Brass, Satin Nickel & Aged Bronze
Colonial Door Knocker	•	•				•	• (N/A Aged Bronze)
Classic Door Knocker/Viewer	•	•	•	•	•		•
Classic Door Knocker	•	•	•	•	•		•
Magazine Slot*	•	•	•	•	•		
Mail Slot*	•	•	•	•	•		
Kick Plate	•	•	•	•	•		•

* Mail slot and magazine slot are not available on 003C, 006C, 008P, 009, 420-DS, 420-2P, 420-3P, 110, 243, 440, 240, 449, 460, & 350 door styles. Additionally, magazine slots are also not available on 002C-449 & 003 door styles.

** Peepsite available in Bright Brass, Chrome (recommended for use with Satin Nickel hardware finish) and Aged/Antique (recommended for use with Aged Bronze or Antique Brass hardware finish) with 5-year finish warranty.



OPTIONS

002CP-437, 160BRC

The Hinge Straps, Clavos and Speakeasy are options that can give your entryway an old world look. Combine these options with our Signet® Knotty Alder Series to achieve a rustic or antique style. Hinge Straps, Clavos and Speakeasy are constructed of durable flat black aluminum.

HINGE STRAPS Available on all door styles shown on opposite page

 Available as an Impact Shield product.



CLAVOS Available only on door styles shown with planks on opposite page (002CP-449, 002CP-437, 8' 002CP-449 and 8' 002CP-437)

 Available as an Impact Shield product.



SPEAKEASY Available on all door styles shown below except for 8' 002C-437 and 8' 002CP-437

NOT tested for Certified Wind Load or Impact Shield regions. (Doors with Speakeasy are not ENERGY STAR® certified.)

ProVia does not recommend entry doors with Speakeasy applications in the Northern climate zone. We also recognize some of the North-Central climate zone areas are not suitable for this application as well. We recommend this application to be used only in the South-Central and Southern climate zones. Speakeasy applications carry a 5-year limited warranty. See price book for more details.



Exterior

Interior

IRON DOOR



Exterior

Interior

SEEDY GLASS DOOR

(single pane)

FAUX SPEAKEASY

Enjoy the decorative look of a speakeasy without impeding the energy efficiency of the entry door. Available on all door styles shown below.



SIGNET FIBERGLASS DOOR STYLES

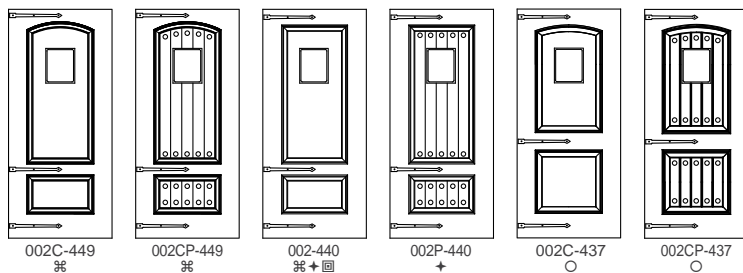

002C-449

002CP-449

002-440

002P-440

002C-437

002CP-437

8' SIGNET FIBERGLASS DOORS

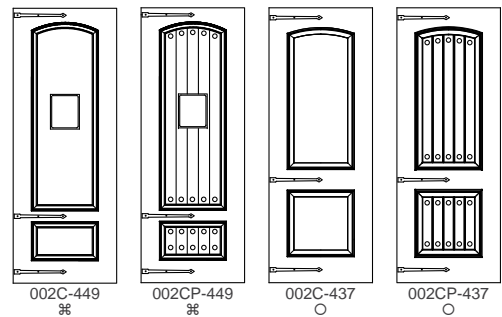

002C-449

002CP-449

002C-437

002CP-437

- ⌘ Signet Cherry Series
- + Signet Oak Series
- Signet Knotty Alder Series
- ⊞ Signet Smooth Series

Options

OPTIONS



FREEDOM PET DOOR

(NOT available in Certified Wind Load or Impact Shield regions)
 (Doors with Pet Door are not ENERGY STAR certified)

Factory Installed - Available on Flush Doors Only

- Solid aluminum construction with locking panel
- Soft single flap for tight weather seal
- Antique White mitered aluminum frame
- Available on the following styles: 001, 430DC-F, 430VNT-F, 430DC-EG-F, 430DC-IGT-F, 100DC, 101DC, 131DC & 306DC
- Also available on storm doors. See pg. 148.

Medium

8 $\frac{1}{8}$ " x 11 $\frac{3}{4}$ " opening for pets up to 40 lbs.

Large

10 $\frac{1}{8}$ " x 15 $\frac{3}{4}$ " opening for pets up to 100 lbs.

X-Large

13 $\frac{5}{8}$ " x 23" opening for pets up to 220 lbs.

Pg. 116 ProVia® Door Price List

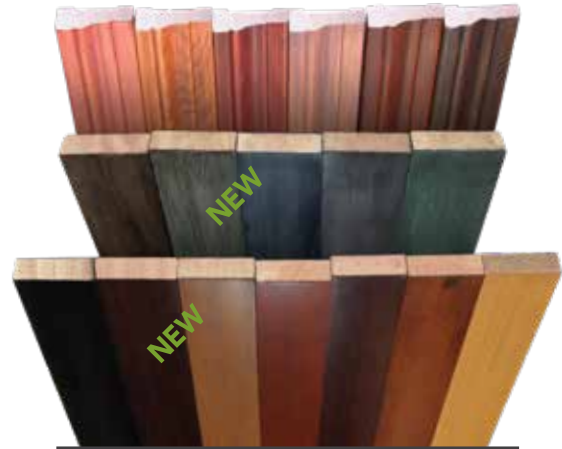

CASING

Put the finishing touch on the inside of your entryway with our beautiful interior casing. Available in Cherry, Mahogany, Fir, Oak or Poplar wood.



2 $\frac{1}{2}$ " Modern



2 $\frac{1}{2}$ " Colonial



3 $\frac{1}{2}$ " Colonial

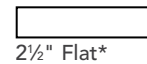

2 $\frac{1}{2}$ " Flat*

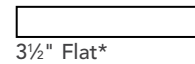

3 $\frac{1}{2}$ " Flat*

Available for any door configuration including transoms.

Signet® stains are available on Cherry, Mahogany, Oak or Fir casing, and Heritage™ and Legacy™ stains are available on Oak or Poplar casing. Paint and glazed finishes are available on Poplar casing.

Custom Casing

Don't see a casing style you need? We have a custom casing program that can meet your needs. Contact your dealer for additional information on our Custom Casing program.

* Only available in Fir and Poplar
 Pg. 122 ProVia® Door Price List



3" Wide Brickmold
 Choose from our standard 2" brickmold or our wider 3" brickmold.

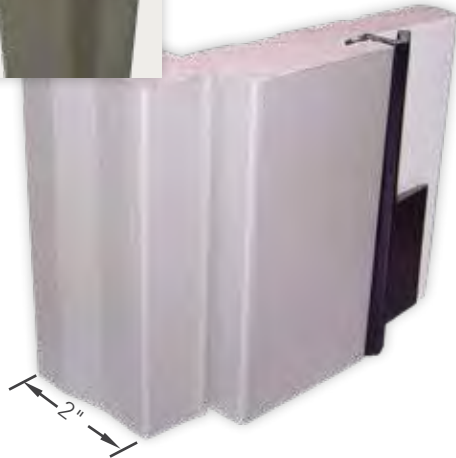

ALUMINUM **PRE-FIT CLADDING**

Cladding is worth the small investment. You can add cladding to any Full Wood or PermaTech™ Composite Frame.

- Protective
- Maintenance-free
- Stays beautiful
- Factory applied

TEXTURED CLADDING COLORS

Snow Mist	Café Cream	Chateau
Sandpiper Beige	Sandstone	Sterling Gray
Clay	Geneva Blue	Forest Green
Mountain Berry	Rustic Bronze	Tudor Brown
Coal Black	Oak	Cherry

TUFTEX **SMOOTH CLADDING** COLORS

Aluminum trim coil with mar-resistant smooth finish.

Snow Mist	Sandpiper Beige	Sandstone◊	Classic Bronze*
-----------	-----------------	------------	-----------------

◊ Smooth Sandstone cladding is a close match, but not an exact match to Sandstone paint color.

* Smooth Classic Bronze cladding does not match Rustic Bronze cladding color or Rustic Bronze paint color.

8' DOORS

8' Doors provide a majestic first impression. Choose from many available glass and door styles (shown on pgs. 34-93). Trilennium® multi-point hardware offers homeowners better door closure and sealing than a single point lock.



440BRC, 140BRC

Trilennium multi-point hardware is required on all 8' fiberglass doors. See pages 104-105 for more information on Trilennium hardware.



8' Doors

440FLO

FRENCH DOORS



460BRZ, 532DC-IGS

French doors make an elegant statement like nothing else. Express your personality by creating a simple yet striking entry. Make it as ornate and beautiful as you like.

- All door styles are available as a French Door
- Available with Full Wood Frame or Steel L-Frame
- Hinged on each end with door knobs in the center
- Available with either left or right active door (main entryway)
- Center astragal is attached to the inactive door and includes top and bottom slide bolts (used to open inactive door)
- Available as inswing or outswing
- Header security plate standard on Full Wood Frame
- Hardware Installation: locksets, deadbolts and kickplates will be installed on active and inactive doors, all other hardware on active door only
- Optional InVent™ Retractable Screens

ASTRAGAL DETAILS The French Door Astragal provides functionality and security



Astragal secures inactive door at top and bottom of your french door system



Lockable throw bolts improve security



Astragal bolt penetrates threshold allowing boot to seal, creating a better barrier against the elements



Astragal is stained to match Signet Fiberglass stained doors.

STYLES/CONFIGURATIONS All door styles are available as a French Door.

Custom size clear glass transom pg. 106

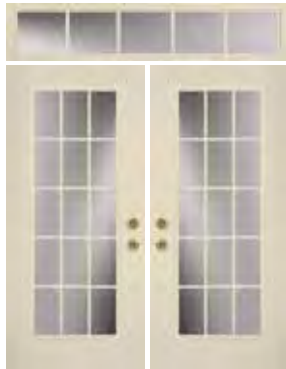

460DC-IGT 460DC-IGT



160SYA 460SYA 460SYA 160SYA



460LAU 460LAU

Cannot be mulled with Heritage Fiberglass doors in Certified Wind Load regions



UNEQUAL FRENCH DOORS

You now have the ability to utilize the larger entry door day-to-day, yet have the option to open the smaller, inactive door to gain full access.

Available in smooth steel only. Internal blind sizes are limited. See Price List for details.

DESIGNER™ HINGED PATIO DOOR

Designer Hinged Patio Doors are swinging patio door systems available in 2 or 3-lite units and constructed of the same solid quality Signet® and Heritage™ Fiberglass, and Legacy™ Woodgrain Textured or Smooth Steel doors as our entry door units.



IMPACT SHIELD AVAILABLE
See pgs. 167 for available door styles

Designer Patio Doors with Heritage Fiberglass
are NOT available in Certified Wind Load regions.



PATIO DOOR STANDARD FEATURES



A keyed Schlage® flair handleset with a Maximum Security thumbturn deadbolt is included. Choose from bright brass, antique brass, satin nickel or aged bronze finish. Optional Lifetime finishes available.



The lock area is reinforced with a 20-gauge steel security plate for added strength.



Spring-loaded latch system automatically engages upon closing. Latch also includes interior locking feature. BetterVue® fiberglass screen mesh is standard. Heavy-duty fiberglass, aluminum or SeeVue® stainless steel screen is optional.



Suspended by ball bearing rollers this top-hung heavy-duty aluminum screen frame reduces binding, creating effortless operation. Screen frames are available in all 16 paint colors.

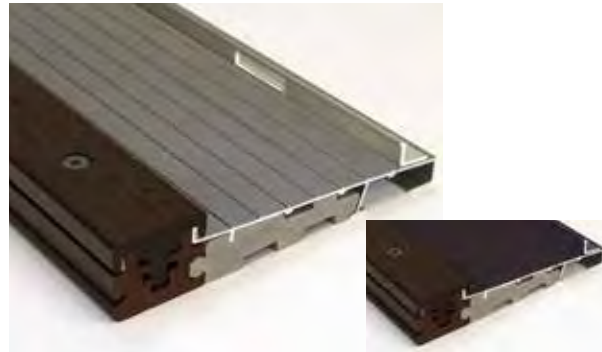

Our Sahara™ heavy-duty extruded sill has a 1½" wide thermal barrier wood-like riser that will not rot or warp and is non-conductive. Available in Anodized Nickel finish or Anodized Bronze finish.

 Thresholds for Impact Shield rated Hinged Patio Doors have an oak-like riser and do not have composite base material

DOOR SWING

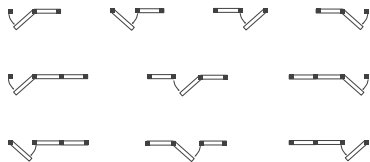

OPTIONS



Custom Widths and Heights - Need a little more height or a little less width? We are pleased to offer customized patio door widths and heights in 1/8" increments.

Door Swing - (Doors viewed from above. Inswing only)

Finishes - Patio doors are available in all finishes shown on pages 21-29.

Optional InVent™ Retractable Screen - See page 110.

STANDARD SIZING INFORMATION

Patio Unit Sizing	Downsized (Standard) Patio Doors					Full Size Patio Doors				
	Patio Width	Unit Size	Rough Opening	Brickmold to Brickmold*	Patio Height	Patio Width	Unit Size	Rough Opening	Brickmold to Brickmold*	Patio Height
	60"	59 ¹ / ₆ "	60 ³ / ₆ "	61 ¹ / ₆ "	Rough Opening Height 79 ⁷ / ₈ "	60"	61 ⁵ / ₈ "	62 ³ / ₈ "	64 ¹ / ₈ "	Rough Opening Height 82"
	64"	63 ⁷ / ₆ "	64 ³ / ₆ "	65 ¹ / ₆ "		64"	65 ⁵ / ₈ "	66 ³ / ₈ "	68 ¹ / ₈ "	
	68"	67 ¹ / ₆ "	68 ³ / ₆ "	69 ¹ / ₆ "		68"	69 ⁵ / ₈ "	70 ³ / ₈ "	72 ¹ / ₈ "	
	72"	71 ¹ / ₆ "	72 ³ / ₆ "	73 ¹ / ₆ "		72"	73 ⁵ / ₈ "	74 ³ / ₈ "	76 ¹ / ₈ "	
	90"	88 ⁵ / ₆ "	89 ⁵ / ₆ "	91 ¹ / ₆ "	Unit Height Not Including Brickmold 79 ³ / ₈ "	90"	91 ³ / ₄ "	92 ¹ / ₂ "	94 ¹ / ₄ "	Unit Height Not Including Brickmold 81 ⁵ / ₈ "
	96"	94 ⁵ / ₆ "	95 ⁵ / ₆ "	97 ¹ / ₆ "		96"	97 ³ / ₄ "	98 ¹ / ₂ "	100 ¹ / ₄ "	
	102"	100 ⁵ / ₆ "	101 ⁵ / ₆ "	103 ¹ / ₆ "		102"	103 ³ / ₄ "	104 ¹ / ₂ "	106 ¹ / ₄ "	
	108"	106 ⁵ / ₆ "	107 ⁵ / ₆ "	109 ¹ / ₆ "		108"	109 ³ / ₄ "	110 ¹ / ₂ "	112 ¹ / ₄ "	

* Optional Aluminum Frame Cladding will increase brickmold to brickmold width by 1/4" and height by 1/8". Not all sizes available in all door types.

VINYL SLIDING PATIO DOORS

Vinyl Sliding Patio Doors are tested against the most stringent industry standards for air and water infiltration, wind load resistance, ease of operation, forced entry and much more. This means you'll have lower heating and air-conditioning costs, easier cleaning, low maintenance and increased comfort.



IMPACT SHIELD AVAILABLE
See pgs. 167 for available door styles

LIFETIME LIMITED WARRANTY
Includes Glass Breakage & Seal Failure



Endure™ Patio Door



All Vinyl Sliding Patio Doors are ENERGY STAR® Certified



Suspended by ball bearing rollers this top-hung heavy duty aluminum screen frame with BetterVue® fiberglass mesh reduces binding, creating effortless operation.



Strong, multi-chamber profiles and 5 7/8" frame depth offer greater thermal efficiency and increased sound abatement. (Endure Patio Door frames have Neopor® insulation).

AccuVent™ is ProVia's proprietary design featuring a sash lever combined with a top mounted ratchet and lock system allowing multiple venting locations and peace of mind. Available in all patio door colors along with optional decorative finishes for sash lever.



AccuVent™ has a clean, sophisticated look with an ergonomic finger-tipped lever design for ease of use. AccuVent is standard for Endure, optional for Aspect and has a Lifetime Warranty.



Spring-loaded latch system automatically engages upon closing. Latch also includes interior locking feature. BetterVue® fiberglass mesh is standard; heavy-duty fiberglass, stainless steel or aluminum mesh is optional.



Galvanized steel reinforced panels ensure rigidity and stable operation.



Sill is reinforced with galvanized steel. Pair that with our patented water draining system, and the results are an efficient and durable base for our patio door.



Fixed and mobile panel rails meet and interlock perfectly, making removal from the outside virtually impossible. Lower sill design provides safer entry and exit.



The vent lock adds peace of mind when you want to leave the door open for ventilation yet keep would-be intruders out. Standard for Aspect, optional for Endure.



Patented sliding system features four adjustable 1" wheels per operating panel to ensure smooth, easy and quiet operation.

Vinyl Sliding Patio Doors

OPTIONS

INTERNAL GRIDS



Internal Grids
(Triple Glazed Glass)



Internal Grids
(Double Glazed Glass)



Contoured

Flat

SAMPLE GRID PATTERNS



Colonial 2V5H



Cottage 1V2H



Double Prairie



Cottage TS-2V1H



Single Prairie

INTERNAL BLINDS (NOT tested for Impact Shield regions)



- Ultra-Privacy edge channel design keeps out light and prying eyes
- Blinds tilt, raise and lower using the convenient fingertip adjustment slides
- Easy to clean; no more dusting of blinds
- 10-Year Limited Warranty
- Available in standard and custom sizes (see price list for availability)
- Available in white blinds only
- Available in 1, 2, 3 and 4 lite models



Blinds with Low-E on surface
2 and 4 are ENERGY STAR®
certified nationwide

CONFIGURATION Available in 2, 3 or 4-panel configurations and standard and custom sizes

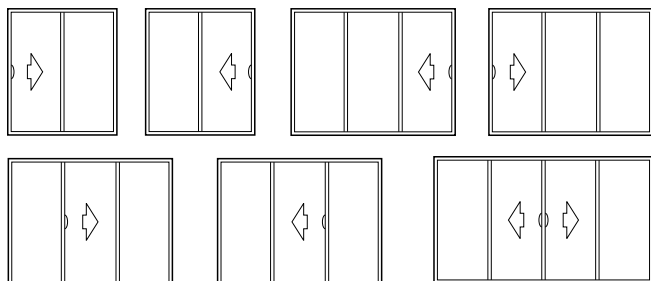

Only available in 2-panel configuration in Certified Wind Load regions. Sidelites and transoms must be installed in a separate opening or use approved engineering mulls.

Only available in 2-panel configuration in Impact Shield regions. Sidelites and transoms are NOT available.

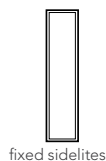

PATIO DOOR & INTERNAL GRID COLORS

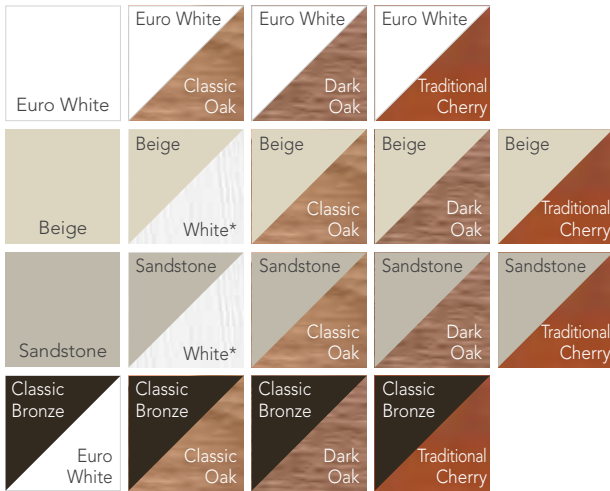

* Laminated with grained texture
Please refer to color selector for accurate color representation

HARDWARE Standard Mortise Hardware



Optional Mortise Hardware (with keylock)

Schlage® C Keyway on all keyed locking handles allow single key entry for the entire house (Also optional for Aspect)



OTHER OPTIONS

- Inspirations™ Art Glass
- ComforTech™ DLA-UV (standard), DLA-UV-HC, TLA-UV and TLK-UV. **NOT tested for Impact Shield regions.**
- Tinted glass: Gray Tint (Solargray®), Bronze Tint (Solarbronze®), Green Tint (Solexia®) or Blue Tint (Azuria®)
- Privacy glass
- Single and Double Prairie beveled glass
- 8' wide units can be ordered assembled or knock-down. For Impact Shield regions, units less than 6' (width) x 6'8" (height) can be ordered assembled or knock-down. All larger units will be ordered knock-down.

PATIO DOOR & INTERNAL GRID COLORS

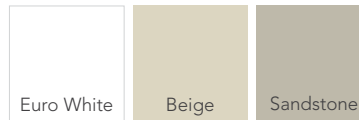

Please refer to color selector for accurate color representation

HARDWARE Standard Mortise Hardware



Optional Mortise Hardware (with keylock)



*Flat Bronze coordinates (but is not an exact match) with Aged Bronze accessories.

OTHER OPTIONS

- ComforTech™ DLA (standard), DLA-HC, TLA and TLK. **NOT tested for Impact Shield regions.**
- Tinted glass: Gray Tint (Solargray®), Bronze Tint (Solarbronze®), Green Tint (Solexia®) or Blue Tint (Azuria®)
- Privacy glass
- Single and Double Prairie beveled glass
- 8' wide units can be ordered assembled or knock-down. For Impact Shield regions, units less than 6' (width) x 6'8" (height) can be ordered assembled or knock-down. All larger units will be ordered knock-down.

STORM DOORS

Every storm door is individually customized to the highest standards in the residential market for homeowners who appreciate impeccable, uncompromising quality.

All ProVia Storm Doors are available for use in the Impact Shield regions. While storm doors help protect your entry door from the elements, they are NOT wind-borne debris tested, and therefore are NOT considered an Impact Shield Product.



389 Self-Storing



Durable, oven-baked polyester finishes are backed by a Lifetime Warranty for lasting beauty and low maintenance.



Extruded aluminum frame adds beauty to your door by virtue of the rounded cove molding along the glass edge of the extrusion.



You'll appreciate the finished look of our **color matched aluminum installation screw covers**.



All our storm doors are constructed with **tempered safety glass**.

Non-operable sashes are secured by our **color matched polycarbonate clips** or an **internal sash lock system**. Varies by model.



Smooth function is essential. That's why we include a **quality door closer** in every storm door package. Varies by model.

Each door features **quality hardware** that adds beauty and functionality to your new storm door. Varies by model.

Our air release system features a continuous closing action without the delayed rebound action of previous generation closers.



Corrosion-proof corner gussets enhance the structural integrity of the door.



Our **bottom expander with sweep** allows for a beautiful custom-fit to any entry. Varies by model.

Storm Doors

STORM DOOR DETAILS

The details are the small things that set our storm doors apart from the competition. A lot of small things add up to a big difference.

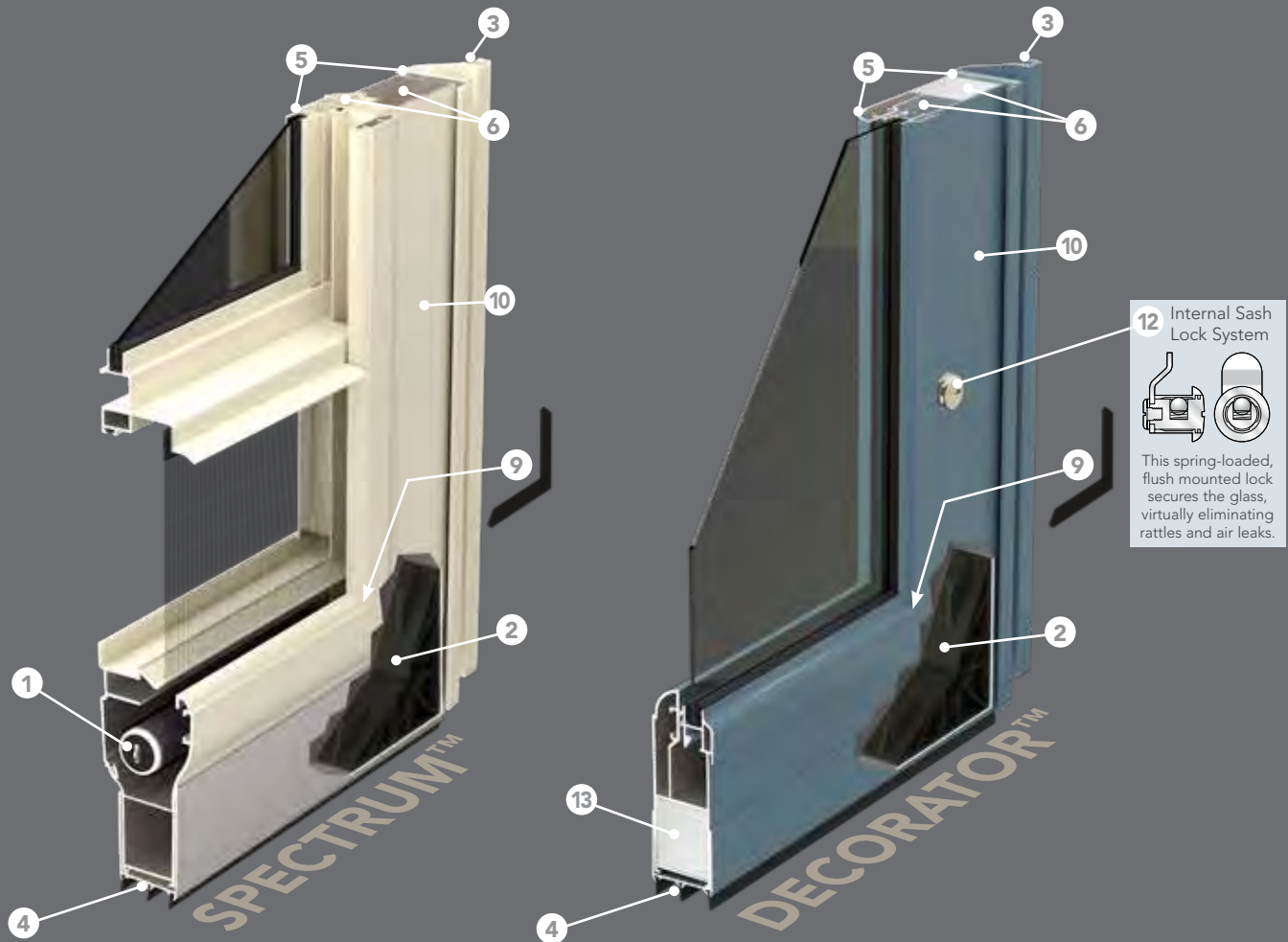

CONSTRUCTION	Spectrum™	Decorator™	Deluxe™	DuraGuard™	Superview™
1 InVent™ Retractable Screen System	●				
2 Outside corners are secured to corrosion-proof gussets, for structural integrity	●	●	●	●	●
3 Color matched aluminum installation screw covers enhance the appearance of your door	●	●	●	●	●
4 The bottom sweep eliminates drafts	Triple	Triple	Double	Double	Single
5 The sculptured frame adds durability	1¼" x 4¾"	1¼" x 4"	1¼" x 3¾"	1¼" x 3¾"	1¼" x 2¾"
6 Multi-hollow construction provides greater strength and security than standard storm doors	●	●	●	●	
7 The reinforced aluminum kick panel adds durability	●		●	●	
8 The aluminum kick panel resists rust and adds strength	●		●	●	●
9 Corner keys provide added support to the inside of the door frame	●	●	●	●	
10 Aluminum wall thickness up to 20% thicker than industry standard	●	●	●	●	
11 The .023 gauge stainless steel screen offers extra security and protection (12 x 12 mesh)				●	
12 Non-operable sash/screen secured by internal lock system or color matched polycarbonate clips		Internal Lock	Clips	Clips	Clips
13 Standard insulated frame core to help reduce air movement	Optional	●	Optional	Optional	
14 Screen included	●	Optional	●	●	●

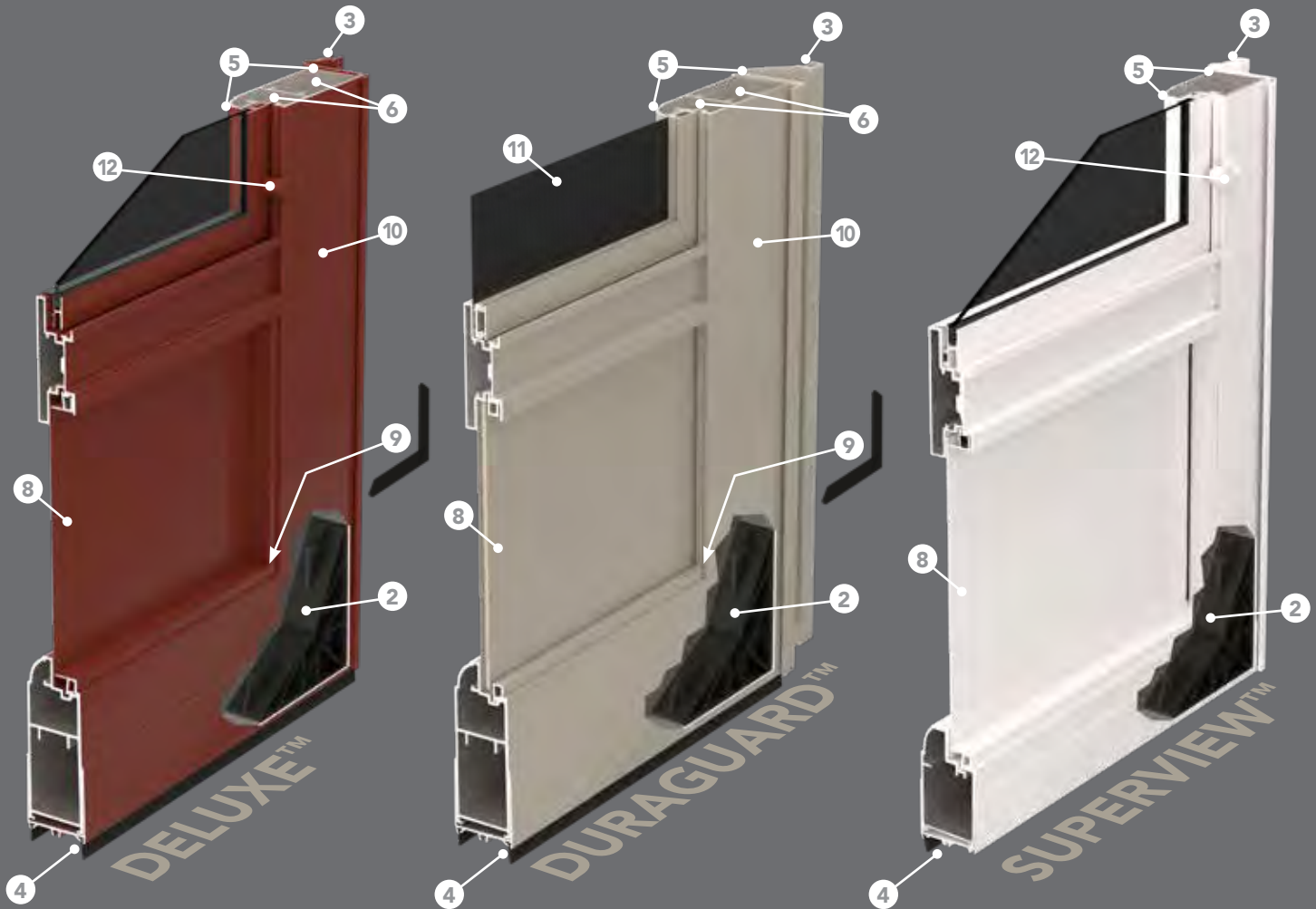

STORM DOOR PAINT FINISHING SYSTEM

Our paint process is computer controlled, ensuring professional quality every time. Paint is electrostatically applied with a vertical hydraulic reciprocator using a turbo disc that atomizes the paint particles for better coverage of contoured extrusions.

LIFETIME FINISH WARRANTY

For all Storm Doors

STORM DOOR PAINT COLORS

Always refer to our color selector for accurate color representation.

Snow Mist	Café Cream	Primrose Yellow †	Chateau	Sandpiper Beige	Sandstone	Sterling Gray	Clay
Geneva Blue	Enzian Blue †	Forest Green	Vallis Red †	Mountain Berry	Rustic Bronze	Tudor Brown	Coal Black

† Limited Colors. Available on entry doors and storm doors. Matching cladding and caulking not available.



291 Full View



Featuring top and bottom InVent™ Retractable Screens

SPECTRUM™

STORM DOORS

Spectrum Series storm doors bring you smooth functionality, beauty and durability. Our exclusive top and bottom InVent™ retractable screen system allows you more venting options than ever.

SPECTRUM STORM DOORS INCLUDE:

- Two InVent™ retractable screens
- Triple seal bottom sweep
- 1¼" x 4¾" wide sculptured frame

LIFETIME LIMITED WARRANTY

Includes Glass Breakage

STANDARD HARDWARE & ACCESSORIES



Satin Nickel Sierra solid brass Mortise Hardware ◊

NOT recommended or warranted for coastal applications

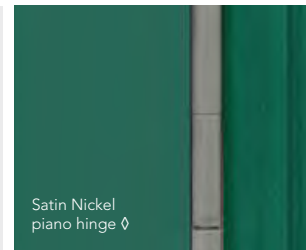

Satin Nickel piano hinge ◊



1½" Satin Nickel bottom expander ◊

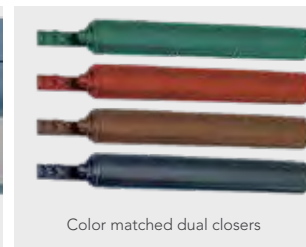

Color matched dual closers



#295-B Full View Double Prairie with Beveled Glass and Brass Inlay ◊



#295-Z Full View Double Prairie with Beveled Glass and Zinc Inlay



#295 Full View Double Prairie with Beveled Glass



#291 Full View (Inspirations Glass available)



#298-B Three-Quarter View with Beveled Glass and Brass Inlay ◊



#298-Z Three-Quarter View with Beveled Glass and Zinc Inlay



#298-VG Three-Quarter View with Beveled Glass



#298 Three-Quarter View (Inspirations Glass available)



#279-C Colonial Half-Lite ‡



#292 Provincial Half-Lite ‡



#293 Crossbuck Half-Lite ‡



#279 Flush Half-Lite ‡



#291SH Full View (Only one InVent top screen and fixed bottom sash)



#298SH Three-Quarter View (Only one InVent top screen and fixed bottom sash)



#274-CSH Colonial Half-Lite (Only one InVent top screen and fixed bottom sash) * ‡



#274SH Half-Lite (Only one InVent top screen and fixed bottom sash) * ‡



#298-AME Americana (Timberland)

#298-AZT Aztec (Coral Reef)

#298-TUL Tulips (Vineyard)

INSPIRATIONS™ ART GLASS

Ask to see our Inspirations™ Art Glass brochure for our complete selection of designs, color palettes and style availability.

* When top sash opens, it passes in front of kick panel

◊ Bright Brass hardware, brass-look piano hinge and brass-look bottom expander are standard on Spectrum storm doors with brass caming.

‡ Available in 8' height

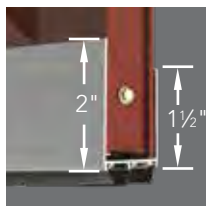

Note: The bottom expander on the Spectrum storm door is 2" on the exterior and 1½" on the interior to accommodate the frame profile



For French Storm Door information refer to pg. 172 of the ProVia® Door Price List

Spectrum Storm Doors



595 Full View Double Prairie with Beveled Glass

DECORATOR™

STORM DOORS

Decorator Series provides a stylish, fresh look to accent your entry. Select one of the distinct styles from our Decorator Series storm doors.

DECORATOR STORM DOORS INCLUDE:

- Triple seal bottom sweep
- 1¼" x 4" wide sculptured frame

LIFETIME LIMITED WARRANTY

Includes Glass Breakage

STANDARD HARDWARE & ACCESSORIES



Bright Brass Windsor Hardware ◊

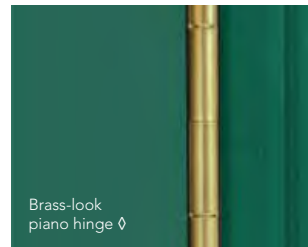

Brass-look piano hinge ◊

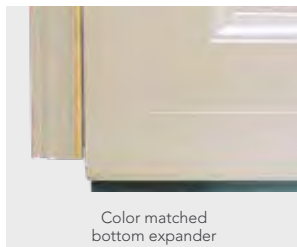

Color matched bottom expander



Color matched dual closers



#591 Full View Archway with Beveled Glass ‡



#591-B Full View Archway with Beveled Glass & Brass Inlay ‡



#591-Z Full View Archway with Beveled Glass & Zinc Inlay ◊ ‡



#595 Full View Double Prairie with Beveled Glass ‡



#595-B Full View Double Prairie with Beveled Glass & Brass Inlay



#595-Z Full View Double Prairie with Beveled Glass & Zinc Inlay ◊



#590 Full View ‡



590-WES Westin ◊ ‡

590-VIN Vintage (Timberland) ◊ ‡

INSPIRATIONS™ ART GLASS

Ask to see our Inspirations™ Art Glass brochure for our complete selection of designs, color palettes and style availability.



This spring-loaded, flush mounted lock secures the glass, virtually eliminating rattles and air leaks. Only available in Zinc finish

Optional full screen with horizontal stabilizer bar available for all Decorator doors.

◊ Satin Nickel hardware, and Satin Nickel piano hinge are standard on Decorator storm doors with zinc coming or Inspirations Art Glass.

‡ Available in 8' height



For French Storm Door information refer to pg. 172 of the ProVia® Door Price List



DELUXE™

STORM DOORS

Deluxe Series is the answer whether you're looking for additional light, ventilation or protection from the elements. You'll find the exact style you're looking for in our Deluxe Series of storm doors.

DELUXE STORM DOORS INCLUDE:

- Double seal bottom sweep
- 1¼" x 3⅝" wide sculptured frame
- BetterVue® Fiberglass Screen

LIFETIME LIMITED WARRANTY

Includes Glass Breakage

STANDARD HARDWARE & ACCESSORIES



Black Contemporary Curve lever with deadbolt

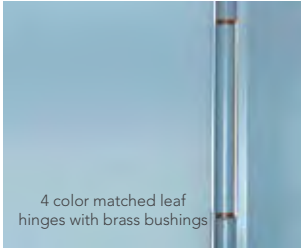

4 color matched leaf hinges with brass bushings

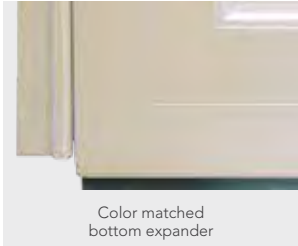

Color matched bottom expander



Heavy-duty color matched closer



#385 Full View Double Prairie with Beveled Glass (Includes screen*) ‡



#382 Full View with Beveled Glass (Includes screen*)



#397 Full View (Includes screen*)



#391 Full View Divided Lite (Includes top screen) ‡



#396-V One-Lite with fixed .023 gauge stainless steel screen ventilated bottom & removable sash (Includes top screen*) ‡ (Inspirations Glass available)



#396 One-Lite (Includes screen*) ‡ (Inspirations Glass available)



#399-M Modern Self-Storing (Includes full screen) ‡
Dent-Resistant Aluminum kick panel



#399 Self-Storing (Includes full screen*) ‡



#398-M Modern Hi-Lite (Includes top screen) ‡
Dent-Resistant Aluminum kick panel



#398 Hi-Lite (Includes top screen) ‡



#389-M Modern Self-Storing (Includes full screen*) ‡
Dent-Resistant Aluminum kick panel



#389 Self-Storing (Includes full screen*) ‡



#379-C Colonial Self-Storing (Includes full screen) ‡
Dent-Resistant Aluminum kick panel



#374-C Colonial Half-Lite (Includes screen) ‡
Dent-Resistant Aluminum kick panel



#392 Provincial Self-Storing (Includes full screen) ‡
Reinforced Aluminum kick panel



#394 Provincial (Includes screen) ‡
Reinforced Aluminum kick panel



#393 Crossback Self-Storing (Includes full screen) ‡
Reinforced Aluminum kick panel



#395 Crossback (Includes screen) ‡
Reinforced Aluminum kick panel



#379 Self-Storing (Includes full screen) ‡
Reinforced Aluminum kick panel



#374 Flush Half-Lite (Includes screen) ‡
Reinforced Aluminum kick panel



#397-VIN Vintage (Timberland)

* Full and One-Lite screens have horizontal stabilizer bar

‡ Available in 8' height

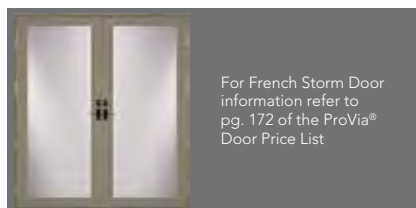

For French Storm Door information refer to pg. 172 of the ProVia® Door Price List

Deluxe Storm Doors

INSPIRATIONS™ ART GLASS

Ask to see our Inspirations™ Art Glass brochure for our complete selection of designs, color palettes and style availability.

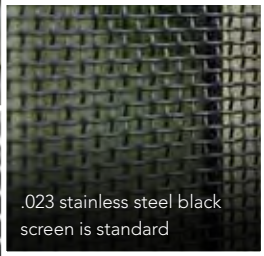

.023 stainless steel black screen is standard



Also available in white



Note: White screen can appear to have different levels of transparency depending on the lighting and background.

097 Screen Door

DURAGUARD™

STORM DOORS

DuraGuard is exactly what you need if you're concerned about keeping your small children and pets safely inside. Select one of our doors with heavy-duty, non-removable stainless steel screening.

DURAGUARD STORM DOORS INCLUDE:

- Non-removable .023 stainless steel screen (only available on DuraGuard models)
- Double seal bottom sweep
- 1¼" x 3½" wide sculptured frame

LIFETIME LIMITED WARRANTY

Includes Glass Breakage

STANDARD HARDWARE & ACCESSORIES



Black Contemporary Curve Hardware

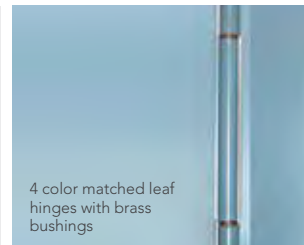

4 color matched leaf hinges with brass bushings

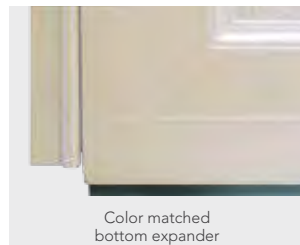

Color matched bottom expander



Heavy-duty color matched closers



#097 Screen Door ‡
#097-G with removable glass insert



#096 Screen Door ‡
#096-G with removable glass insert ‡
Reinforced Aluminum kick panel



#096-GV With ventilated bottom and removable top and bottom sashes ‡



#099 Self-Storing Sash & Screen
Reinforced Aluminum kick panel



#099-M Modern Self-Storing Sash & Screen
Dent-Resistant Aluminum kick panel



#089 Self-Storing Sash & Screen
Reinforced Aluminum kick panel



#089-M Modern Self-Storing Sash & Screen
Dent-Resistant Aluminum kick panel



#074 Flush Half Lite (Removable sash) ‡
Reinforced Aluminum kick panel



#074-C Colonial Half Lite (Removable sash) ‡
Dent-Resistant Aluminum kick panel



#094 Provincial Half Lite (Removable sash) ‡
Reinforced Aluminum kick panel



#095 Crossback Half Lite (Removable sash) ‡
Reinforced Aluminum kick panel



#079 Self-Storing ‡
Reinforced Aluminum kick panel



#079-C Colonial Self-Storing ‡
Dent-Resistant Aluminum kick panel



#092 Provincial Self-Storing ‡
Reinforced Aluminum kick panel



#093 Crossback Self-Storing ‡
Reinforced Aluminum kick panel

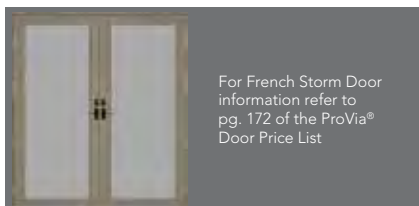

For French Storm Door information refer to pg. 172 of the ProVia® Door Price List

‡ Available in 8' height



SUPERVIEW™

STORM DOORS

Superview offers a selection of storm doors constructed for style and value in one complete package.

SUPERVIEW STORM DOORS INCLUDE:

- Single seal bottom sweep
- 1¼" x 2⅝" wide sculptured frame
- BetterVue® Fiberglass Screen

LIFETIME LIMITED WARRANTY
Includes Glass Breakage

STANDARD HARDWARE & ACCESSORIES



Black Pull Handle
(Also available in white)

4 color matched leaf hinges with brass bushings

Color matched bottom expander

Single Black Closer
(Also available in white)



#897 Full View
(Includes screen*)



#896 One-Lite
(Includes screen*)



#898 Hi-Lite
(Includes top screen)



#899 Self-Storing
(Includes bottom screen)



#895 Crossbuck
(Includes screen)

Superview storm doors are available in the following colors

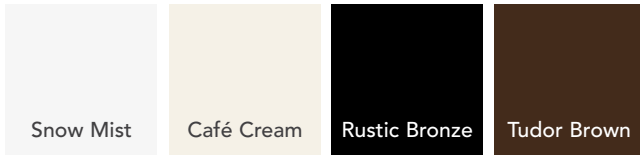

Always refer to our color selector for accurate color representation.

* Full and One-Lite screens have horizontal stabilizer bar

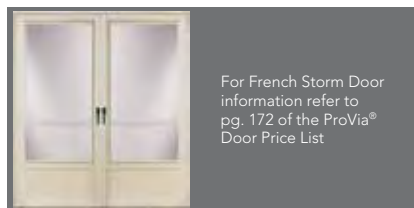

For French Storm Door information refer to pg. 172 of the ProVia® Door Price List

MORTISE HARDWARE

Mortise Hardware adds a special touch to your storm door with a solid brass handleset to suit your style. Our Mortise hardware conveniently allows you to use the same key for your storm door and your ProVia® entry door.



Our Mortise hardware features a multi-point locking system for added strength and security not found on typical consumer-grade storm door hardware.

Satin Nickel Sierra Mortise Hardware

SIERRA (SOLID BRASS MORTISE) (NOT recommended or warranted for coastal applications)



VENICE (SOLID BRASS MORTISE) (NOT recommended or warranted for coastal applications)



HARDWARE FINISH AVAILABILITY

HARDWARE AVAILABILITY

Exterior Handle Styles	LIFETIME Bright Brass	LIFETIME Satin Nickel	LIFETIME Aged Bronze	10-Year Finish Antique Brass	Spectrum™	Decorator™	Deluxe™	DuraGuard™	Superview™
Sierra	●	●	●	●	Standard*	■	■	■	
Venice	●	●	●	●	■	■	■	■	

- Interior handle finish matches exterior handle
- Available as an option

Mortise hardware requires a factory handleset prep and is not available on expander and double french doors.

* Windsor Lever is standard for Impact Shield regions

HARDWARE

With both elegance and durability, our hardware makes the right first impression. Choose from our wide selection of solid hardware to customize your storm door.



Antique Brass Windsor Hardware

WINDSOR



242



241



243



244



245

Interior Handle

(Interior handle finish matches exterior handle)



TOWNSEND



Interior Handle

(Interior handle finish matches exterior handle)



CONTEMPORARY CURVE LEVER



Interior Handle

(Interior handle finish matches exterior handle)



PUSH BUTTON



Interior Handle



Only for Push Button (201 & 202)

(Interior handle finish matches exterior handle)

PULL HANDLE



Interior Handle



Only for Push Button (192) and Pull Handle

(Interior handle finish matches exterior handle)

HARDWARE FINISH AVAILABILITY

Exterior Handle Styles	HARDWARE AVAILABILITY										
	LIFETIME Bright Brass	LIFETIME Satin Nickel	LIFETIME Aged Bronze	1-Year Antique Brass	1-Year White	1-Year Black	Spectrum™	Decorator™	Deluxe™	DuraGuard™	Superview™
Windsor	●	●	●	●		●	■	Standard	■	■	■*
Townsend	●	●	●	●		●	■	■	■	■	■*
Contemporary Curve	●	●	●	●	●	●	■	■	Standard †	Standard †	■*
Push Button (DH201 & DH202)					●	●			■	■	■*
Push Button (DH192)											■
Pull Handle					●	●					Standard †

- Interior handle finish matches exterior handle
- Available as an option
- † Standard color is black
- * Not available on Superview Model #899

ACCESSORIES



FREEDOM PET DOOR

Factory Installed - Available on Flush Doors Only

- Solid aluminum construction with locking panel
- Soft single flap for tight weather seal
- White mitered aluminum frame
- Also available on entry doors. See page 118.
- Also available on additional storm door styles. See Price List pg. 188.
- Only available with heavy-duty closer, Pet Door N/A with dual closers

Medium

8 $\frac{1}{8}$ " x 11 $\frac{1}{4}$ " opening for pets up to 40 lbs.

Large

10 $\frac{1}{8}$ " x 15 $\frac{1}{4}$ " opening for pets up to 100 lbs.

X-Large

13 $\frac{3}{8}$ " x 23" opening for pets up to 220 lbs.



#279 Flush Half-Lite
with Pet Door Option



#379 Self-Storing with Pet Door
Option Includes full screen

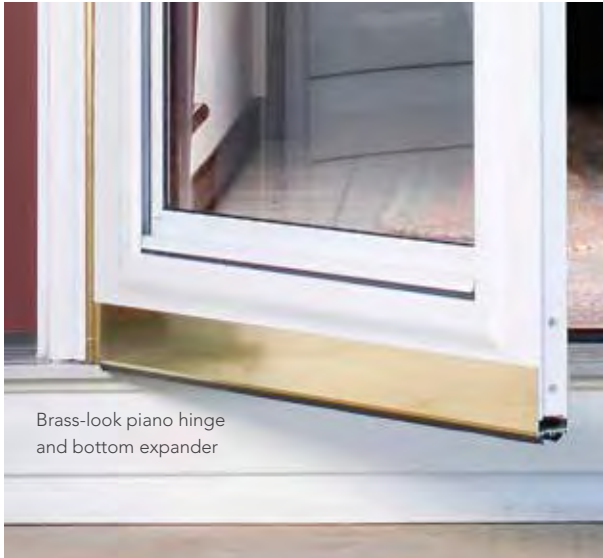

Brass-look piano hinge and bottom expander

PIANO HINGE & BOTTOM EXPANDER



Satin Nickel piano hinge and bottom expander



Aged Bronze piano hinge and bottom expander

Pg. 191 ProVia® Door Price List

Our **air release system** features a continuous closing action without the delayed rebound action of previous generation closers.

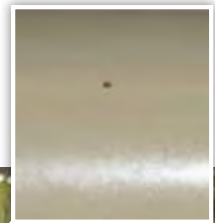

EASY-SET CLOSER

Just a slight push on the cap and it'll stay open. Push door open further and it releases. Color matched to door.

Pg. 191 ProVia® Door Price List



#079 Self-Storing with mail slot option

MAGAZINE & MAIL SLOT

Lifetime Bright Brass, Lifetime Satin Nickel and Lifetime Aged Bronze magazine and mail slots are available on #074, #079, #279, #374 and #379.

Pg. 188 ProVia® Door Price List



FLORIDA

Impact Shield Products are designed to protect your family and home against the harshest storms and deter burglars. All entry systems and patio doors in this Impact Shield Products section are wind-borne debris resistant and approved by the State of Florida. floridabuilding.org

- Impact Shield
- Certified Wind Load
- High-Velocity Hurricane Zones
(ProVia products have not been tested for use in High-Velocity Hurricane Zones)



TEXAS

Impact Shield Products have been tested for the Designated Catastrophe Areas in Texas. Refer to provia.com/certification for a complete listing of approved products.

Designated Catastrophe Areas

TEXAS FIRST TIER COASTAL COUNTIES & CERTAIN AREAS LOCATED IN HARRIS COUNTY EAST OF HWY 146

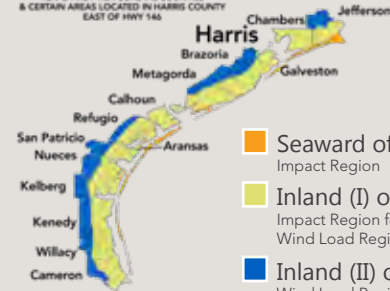

- Seaward of Intracoastal Canal Impact Region
- Inland (I) of Intracoastal Canal Impact Region for All Glazed Product
Wind Load Region for All Opaque Product
- Inland (II) of Intracoastal Canal Wind Load Region

We're constantly testing new Certified Wind Load and Impact Shield products. For the latest information visit: provia.com/certification

All of our Impact Shield Products feature ComforTech™ laminated glass.

ComforTech™ TLK-C
ComforTech™ TLK-UV-C

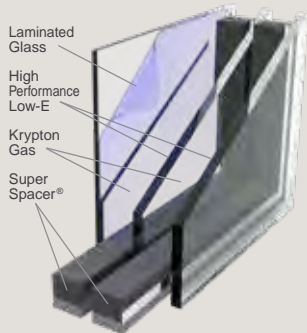

R-Value of 9

ComforTech™ TLA-C
ComforTech™ TLA-UV-C

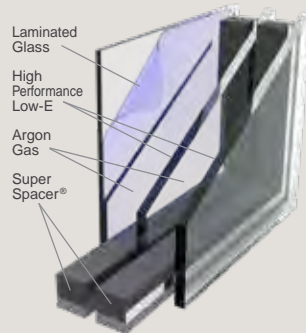

R-Value of 6

ComforTech™ DLA-C
ComforTech™ DLA-UV-C

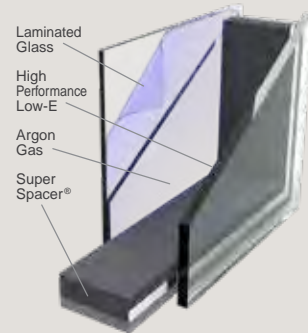

R-Value of 4

ComforTech™ DC-C

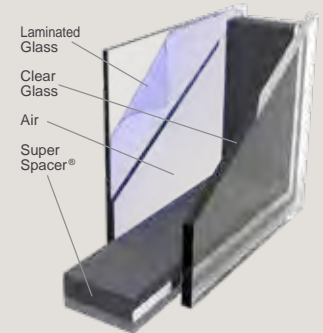

R-Value of 2

R-Value reflects properties of the glass only. Center of glass calculations are based upon software from Lawrence Berkeley National Laboratory.



Entry Systems ComforTech™ Glass Package	R-Value	Solar Heat Gain Coefficient (SHGC)	Visible Light	UV Transmittance
INSULATED GLASS UNIT				
1" ComforTech DC-C	2	0.72	80%	59%
1" ComforTech DLA-C	4	0.39	71%	20%
1" ComforTech DLA-UV-C	4	0.27	63%	5.9%
1½" ComforTech TLA-C	5	0.33	54%	6.9%
1½" ComforTech TLA-UV-C	5	0.23	45%	0.7%
1½" ComforTech TLK-C	6	0.33	54%	6.9%
1½" ComforTech TLK-UV-C	6	0.23	45%	0.7%

LIFETIME

— LIMITED WARRANTY —

Includes Glass Breakage
and Seal Failure



Look for indicated
ENERGY STAR® Certified
Impact Shield Products.

ENTRY DOOR AND DESIGNER™ PATIO DOOR IMPACT SHIELD FEATURES

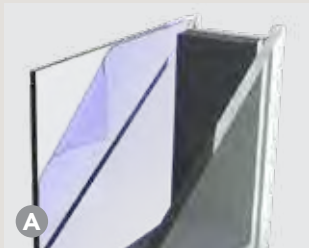

All glass for Impact Shield Products is laminated to provide protection against wind-borne debris.



Heavy-duty stainless steel hinges resist corrosion and are standard in wind-borne debris regions.

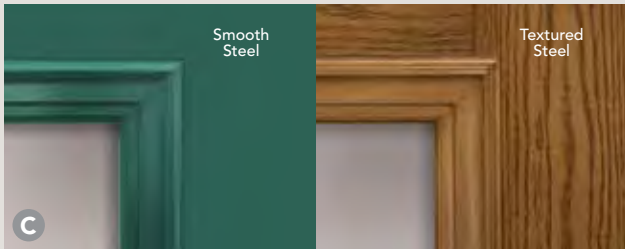

Aluminum window trim of our own exclusive design provides ultimate durability in the harshest of elements. Textured Steel doors have hand-stained smooth aluminum window trim.



VINYL SLIDING PATIO DOOR IMPACT SHIELD FEATURES

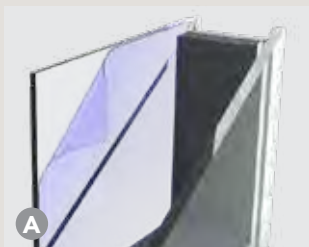

All glass for Impact Shield Products is laminated to provide protection against wind-borne debris.



Additional heavy aluminum interlock on center stile adds durability and strength.



STORM DOORS

All ProVia® storm doors are available for use in the Impact Shield regions. While storm doors help protect your entry door from the elements, they are NOT wind-borne debris tested, and therefore are NOT considered an Impact Shield Product.



ESSENCE

612/613ESZ †** pg. 30



160ESZ pg. 14
460ESZ pg. 12
160ESZ pg. 14



770ESZ§ pg. 16



440ESZ† pg. 10



770ESZ§ pg. 16

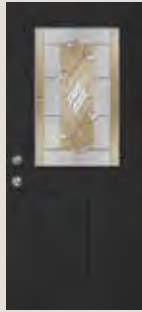

430ESZ† pg. 8

8' Essence



430ESZ pg. 20

CHEYENNE

512/513CHP † pg. 28



160CHP pg. 14
460CHP pg. 12
160CHP pg. 14

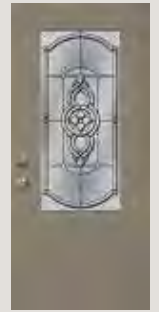

440CHP† pg. 10

8' Cheyenne



430CHP† pg. 8

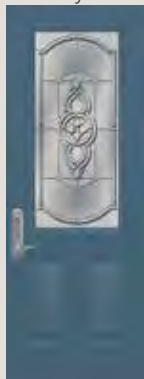

430CHZ pg. 20

BRILLIANCE

512/513BRZ † pg. 28

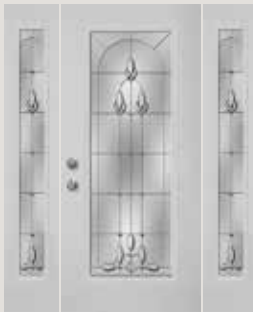

160BRZ pg. 14
460BRZ pg. 12
160BRZ pg. 14



440BRZ† pg. 10



430BRZ† pg. 8

8' Brilliance

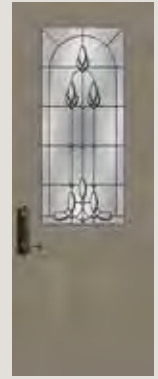

430BRP pg. 20

SYMPHONY

612/613SYA †** pg. 30



160SYA pg. 14
460SYA pg. 12
160SYA pg. 14



770SYA§ pg. 16
440SYA† pg. 10

712/713SYA †** pg. 27



160SYA pg. 14
430SYA† pg. 8
160SYA pg. 14

8' Symphony



430SYA pg. 20



160SYA pg. 23
460SYA pg. 22
160SYA pg. 23

** Requires an additional 4-week lead time

† For additional door panel styles see pg. 22 (for Legacy™)

§ Also available in 10" width. See Price List for design pattern

‡ All transoms must be installed in a separate opening or use approved engineering mulls

NOTE: All doors and sidelites with glass are only available in Smooth or Woodgrain Textured Steel.

Woodgrain Textured Steel is NOT available in 8' doors and sidelites.

Direct-Set sidelites can be used with all door types.

BERKLEY

612/613BEA ** pg. 30



160BEA pg. 14 460BEA pg. 12 160BEA pg. 14

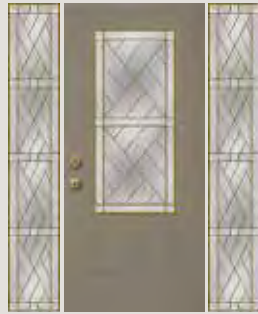

770BEA‡ pg. 16 440BEA† pg. 10 770BEA‡ pg. 16



430BEA† pg. 8

8' Berkley



430BEA pg. 20

LAURENCE

612/613LAU ‡** pg. 30



160LAU pg. 14 460LAU pg. 12 160LAU pg. 14

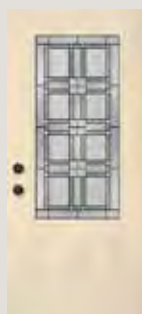

440LAU† pg. 10



430LAU† pg. 8

8' Laurence

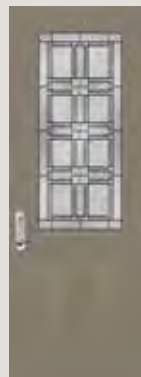

430LAU pg. 20

CARRINGTON

612/613CAR ‡** pg. 30

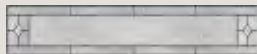

160CAR pg. 14 460CAR pg. 12 160CAR pg. 14

712/713CAR ‡** pg. 27

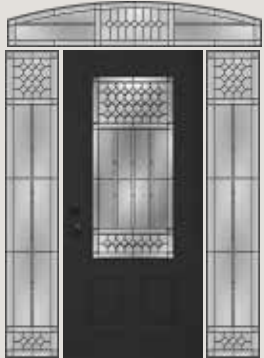

770CAR‡ pg. 16 440CAR† pg. 10 770CAR‡ pg. 16

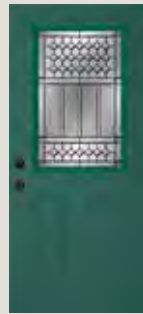

430CAR† pg. 8

8' Carrington

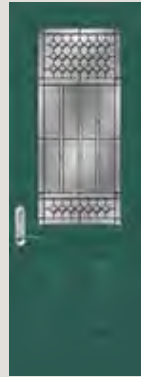

430CAR pg. 20

** Requires an additional 4-week lead time

† For additional door panel styles see pg. 22 (for Legacy™)

‡ All transoms must be installed in a separate opening or use approved engineering mulls

NOTE: All doors and sidelites with glass are only available in Smooth or Woodgrain Textured Steel. Woodgrain Textured Steel is NOT available in 8' doors and sidelites. Direct-Set sidelites can be used with all door types.



TACOMA

612/613TAC †** pg. 30

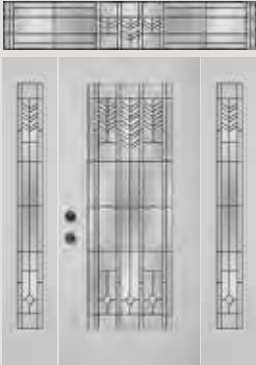

160TAC pg. 14 460TAC pg. 12 160TAC pg. 14



440TAC† pg. 10

8' Tacoma



430TAC pg. 20

SOMERSET

612/613SOM †** pg. 30

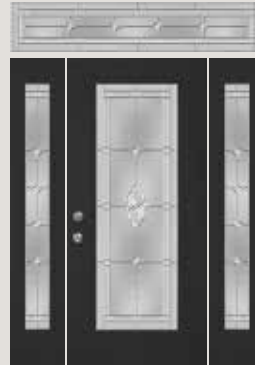

160SOM pg. 14 460SOM pg. 12 160SOM pg. 14

712/713SOM †** pg. 27



770SOM§ pg. 16 440SOM† pg. 10 770SOM§ pg. 16

512/513SOM † pg. 28



160SOM pg. 14 430SOM† pg. 8 160SOM pg. 14

8' Somerset



430SOM pg. 20

CARMEN

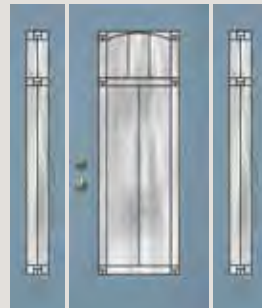

160CRM pg. 14 460CRM pg. 12 160CRM pg. 14



440CRM† pg. 10



430CRM† pg. 8

8' Carmen

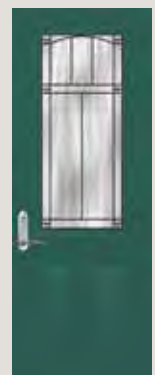

430CRM† pg. 20

Note: The Outside View / Inside View photos shown below also apply to Carmen glass

BARCELONA



160BRC pg. 14 460BRC pg. 12 160BRC pg. 14



440BRC† pg. 10



430BRC† pg. 8

8' Barcelona

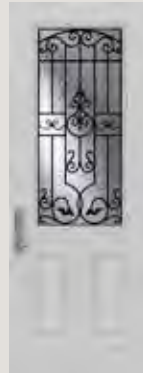

430BRC pg. 20



Outside View



Inside View

Note: In Impact Shield regions, the gluechip glass (or other privacy glass) is positioned to the outside face of the wrought iron.

** Requires an additional 4-week lead time
† For additional door panel styles see pg. 22 (for Legacy™)
§ Also available in 10" width. See Price List for design pattern

‡ All transoms must be installed in a separate opening or use approved engineering mulls
NOTE: All doors and sidelites with glass are only available in Smooth or Woodgrain Textured Steel. Woodgrain Textured Steel is NOT available in 8' doors and sidelites. Direct-Set sidelites can be used with all door types.

LYNFORD

612/613LYN** † pg. 30



160LYN pg. 14 460LYN pg. 12 160LYN pg. 14



770LYN§ pg. 16 440LYN† pg. 10 770LYN§ pg. 16



430LYN† pg. 8

8' Lynford



430LYN† pg. 20

CONSTANCE

612/613COB † ** pg. 30



160COB pg. 14 460COB pg. 12 160COB pg. 14

712/713COZ † ** pg. 27



160COZ pg. 14 440COZ† pg. 10 160COZ pg. 14

512/513COB † pg. 28



770COB§ pg. 16 430COB† pg. 8 770COB§ pg. 16

8' Constance



430COZ pg. 20

TRANQUILITY

612/613TRP † ** pg. 30

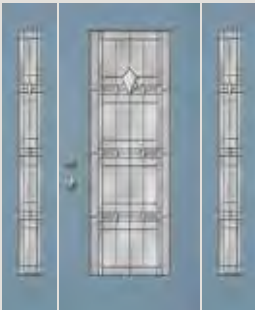

160TRP pg. 14 460TRP pg. 12 160TRP pg. 14



440TRP† pg. 10



430TRP† pg. 8

8' Tranquility



430TRZ pg. 20

** Requires an additional 4-week lead time

† For additional door panel styles see pg. 22 (for Legacy™)

‡ All transoms must be installed in a separate opening or use approved engineering mulls

NOTE: All doors and sidelites with glass are only available in Smooth or Woodgrain Textured Steel. Woodgrain Textured Steel is NOT available in 8' doors and sidelites. Direct-Set sidelites can be used with all door types.



GEMSTONE

612/613GEM ‡ ** pg. 30



160GEM pg. 14 460GEM pg. 12 160GEM pg. 14



440GEM† pg. 10



430GEM† pg. 8

8' Gemstone



430GEM pg. 20

JEWEL

612/613JWL ‡ ** pg. 30



160JWL pg. 14 460JWL pg. 12 160JWL pg. 14

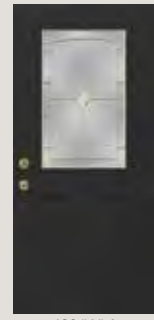

430JWL† pg. 8

ECLIPSE

612/613ECB ‡ ** pg. 30



160ECB pg. 14 460ECB pg. 12 160ECB pg. 14

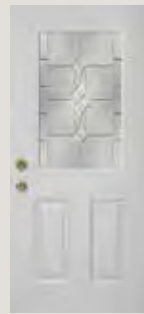

430ECB† pg. 8

FLORENCE

612/613FLP ‡ ** pg. 30

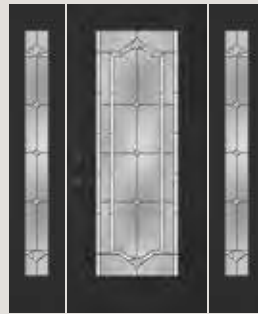

160FLP pg. 14 460FLP pg. 12 160FLP pg. 14



440FLP† pg. 10

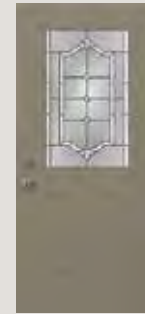

430FLP† pg. 8

8' Florence



430FLP pg. 20

ESMOND

612/613ESM ‡ ** pg. 30



160ESM pg. 14 460ESM pg. 12 160ESM pg. 14

712/713ESM ‡ ** pg. 27



770ESM§ pg. 16 440ESM† pg. 10 770ESM§ pg. 16

512/513ESM ‡ pg. 28



160ESM pg. 14 430ESM† pg. 8 160ESM pg. 14

8' Esmond



430ESM pg. 20

** Requires an additional 4-week lead time

† For additional door panel styles see pg. 22 (for Legacy™)

§ Also available in 10" width. See Price List for design pattern

‡ All transoms must be installed in a separate opening or use approved engineering mulls

NOTE: All doors and sidelites with glass are only available in Smooth or Woodgrain Textured Steel.

Woodgrain Textured Steel is NOT available in 8' doors and sidelites.

Direct-Set sidelites can be used with all door types.

CARLISLE



BEVELED



TWILIGHT

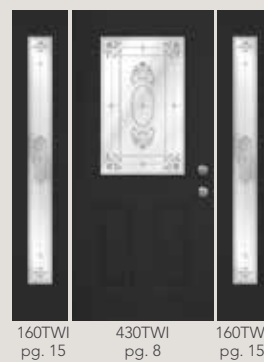

PRIVACY



** Requires an additional 4-week lead time

† For additional door panel styles see pg. 22 (for Legacy™)

‡ All transoms must be installed in a separate opening or use approved engineering mulls

NOTE: All doors and sidelites with glass are only available in Smooth or Woodgrain Textured Steel. Woodgrain Textured Steel is NOT available in 8' doors and sidelites. Direct-Set sidelites can be used with all door types.



INTERNAL GRIDS



612/613DC-IGS ‡ ** pg. 31



712/713DC-IGS ‡ ** pg. 27



512/513DC-IGS ‡ pg. 29



612/613DC-IGT ‡ ** pg. 31



516DC-IGS ‡ pg. 32



616DC-IGT ‡ pg. 29



532DC-IGS ‡ pg. 32



616DC-IGP ‡ pg. 29



460DC-IGT
pg. 13



160DC-IGT
pg. 15



460DC-IGP
pg. 13



160DC-IGP
pg. 15



460DC-IGC
pg. 13



160DC-IGC
pg. 15



440DC-IGT
pg. 11

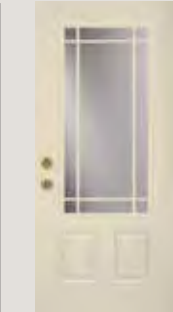

770DC-IGT§
pg. 17



440DC-IGP†
pg. 11

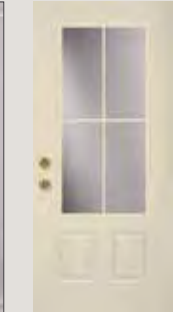

770DC-IGP§
pg. 17



440DC-IGC†
pg. 11

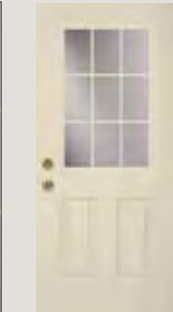

770DC-IGC§
pg. 17



430DC-IGT†
pg. 9

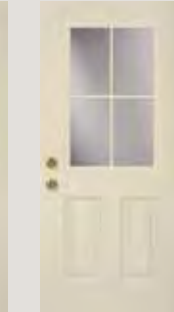

430DC-IGP†
pg. 9



430DC-IGC†
pg. 9

8' Internal Grids



460DC-IGT
pg. 22



460DC-IGC
pg. 22



430DC-IGT
pg. 21



770DC-IGT§
pg. 25



430DC-IGP
pg. 21

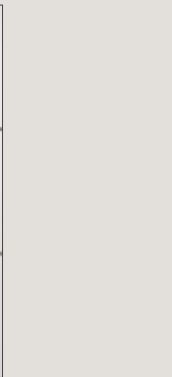

770DC-IGP§
pg. 25

** Requires an additional 4-week lead time

† For additional door panel styles see pg. 22 (for Legacy™)

§ Also available in 10" width. See Price List for design pattern

‡ All transoms must be installed in a separate opening or use approved engineering mulls

NOTE: All doors and sidelites with glass are only available in Smooth or Woodgrain Textured Steel.

Woodgrain Textured Steel is NOT available in 8' doors and sidelites.

Direct-Set sidelites can be used with all door types.

CLEAR GLASS



512/513DC ‡ pg. 29



712/713DC ‡** pg. 27



612/613DC ‡** pg. 31



616DC ‡ pg. 29



532DC ‡ pg. 32



516DC ‡ pg. 32

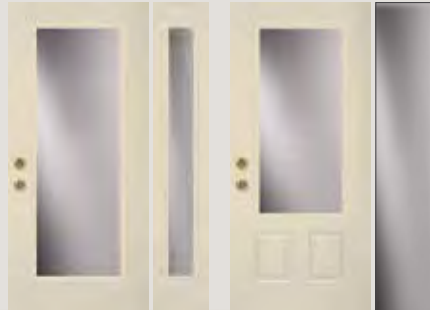

460DC
pg. 13

160DC
pg. 15

440DC†
pg. 11

770DC§
pg. 17



460 Clear Glass entry systems with TLK-C are ENERGY STAR® Certified.
440 Clear Glass entry systems with TLA-C or TLK-C are ENERGY STAR Certified.

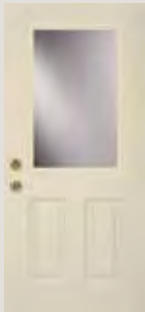

430DC†
pg. 9

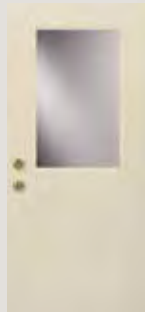

430DC-F†
pg. 9

8' Clear Glass



460DC
pg. 22

160DC
pg. 23



430DC
pg. 21

770DC§
pg. 25



430DC-2P

** Requires an additional 4-week lead time
† For additional door panel styles see pg. 22 (for Legacy™)
§ Also available in 10" width

‡ All transoms must be installed in a separate opening or use approved engineering mulls
NOTE: All doors and sidelites with glass are only available in Smooth or Woodgrain Textured Steel. Woodgrain Textured Steel is NOT available in 8' doors and sidelites. Direct-Set sidelites can be used with all door types.



All Doors Without Glass are ENERGY STAR® Certified.

DOORS WITHOUT GLASS See chart on pg. 88 for style availability

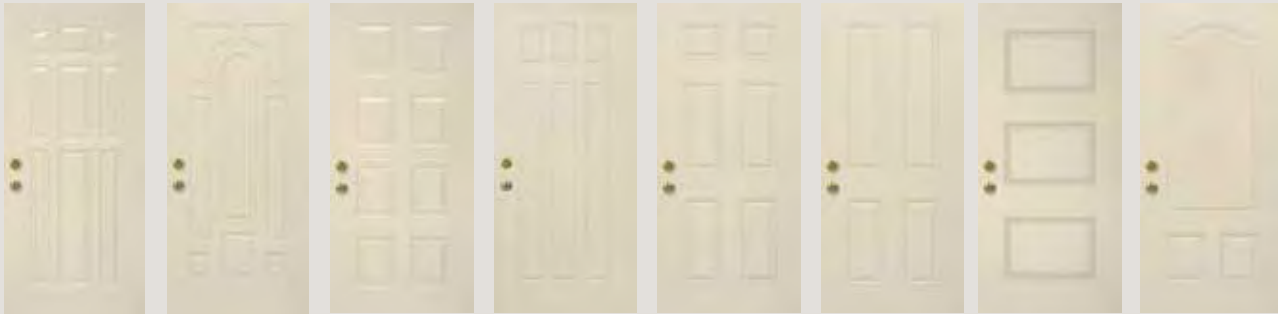

009
pg. 7

008P
pg. 7

008
pg. 7

006C
pg. 7

006
pg. 6

004
pg. 6

003M
pg. 6

003
pg. 6

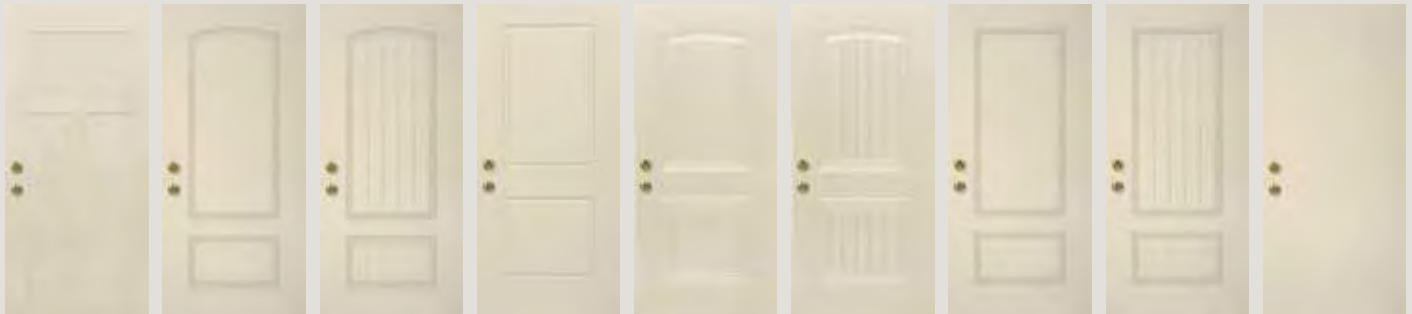

003C
pg. 6

002C-449
pg. 5

002CP-449
pg. 5

002
pg. 5

002C-437
pg. 5

002CP-437
pg. 5

002-440
pg. 5

002P-440
pg. 5

001*
pg. 7

8' Doors Without Glass

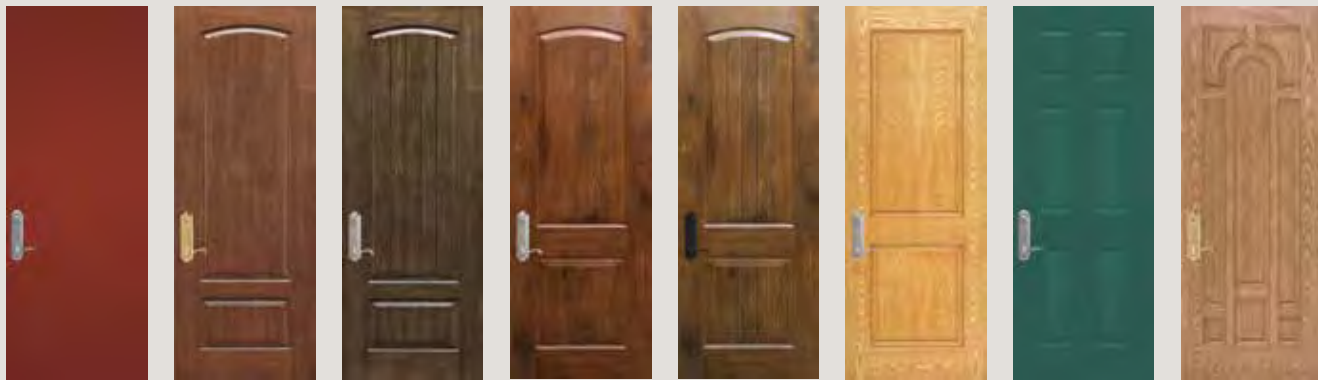

001
pg. 19

002C-449
pg. 19

002CP-449
pg. 19

002C-437
pg. 19

002CP-437
pg. 19

002
pg. 19

006
pg. 19

008P
pg. 19

* Not available in Signet®

‡ All transoms must be installed in a separate opening or use approved engineering mulls

NOTE: All doors and sidelites with glass are only available in Smooth or Woodgrain Textured Steel.

Woodgrain Textured Steel is NOT available in 8' doors and sidelites.

Direct-Set sidelites can be used with all door types.

INSPIRATIONS™ ART GLASS

VOYAGE



460VOY
pg. 13

160VOY
pg. 15

440VOY†
pg. 11

770VOY§
pg. 17

430VOY†
pg. 9



512/513VOY ‡ pg. 28

612/613VOY ‡** pg. 31

532VOY ‡ pg. 32

8' Voyage

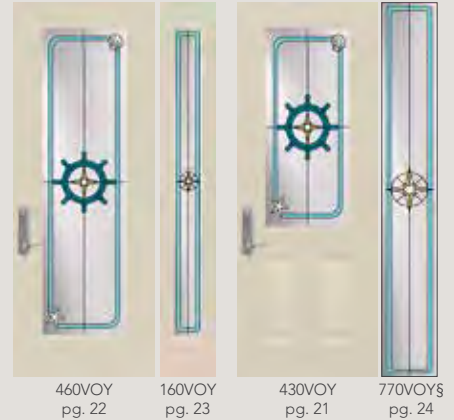

460VOY
pg. 22

160VOY
pg. 23

430VOY
pg. 21

770VOY§
pg. 24

HARBOR



460HBR
pg. 13

160HBR
pg. 15

440HBR†
pg. 11

770HBR§
pg. 17

430HBR†
pg. 9



512/513HBR ‡ pg. 28

612/613HBR ‡** pg. 31

532HBR ‡ pg. 32

8' Harbor

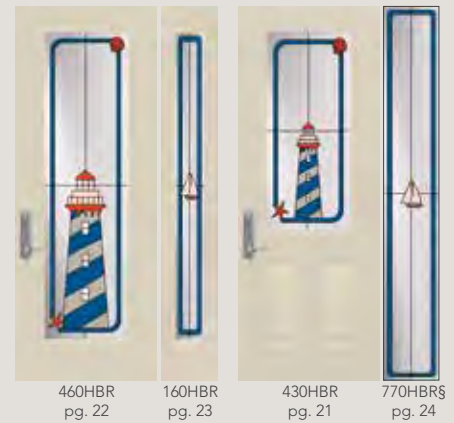

460HBR
pg. 22

160HBR
pg. 23

430HBR
pg. 21

770HBR§
pg. 24

AMERICANA



460AME
pg. 13

160AME
pg. 15

440AME†
pg. 11

770AME§
pg. 16

430AME†
pg. 9



512/513AME ‡ pg. 28

612/613AME ‡** pg. 30

532AME ‡ pg. 32

8' Americana



460AME
pg. 22

160AME
pg. 23

430AME
pg. 21

770AME§
pg. 24

** Requires an additional 4-week lead time
† For additional door panel styles see pg. 22 (for Legacy™)
§ Also available in 10" width. See Price List for design pattern

‡ All transoms must be installed in a separate opening or use approved engineering mulls
NOTE: All doors and sidelites with glass are only available in Smooth or Woodgrain Textured Steel. Woodgrain Textured Steel is NOT available in 8' doors and sidelites. Direct-Set sidelites can be used with all door types.



VINTAGE

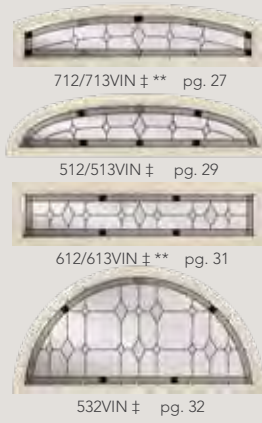

532VIN ‡ pg. 32

8' Vintage



LINCOLN

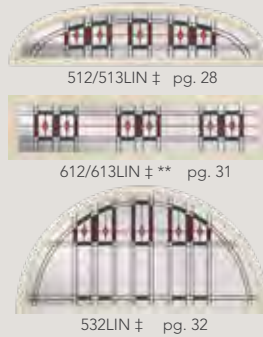

8' Lincoln



TULIPS

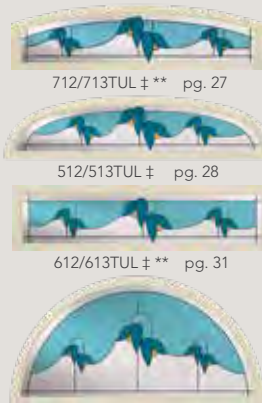

532TUL ‡ pg. 32

8' Tulips



** Requires an additional 4-week lead time
† For additional door panel styles see pg. 22 (for Legacy™)
§ Also available in 10" width. See Price List for design pattern

‡ All transoms must be installed in a separate opening or use approved engineering mulls
NOTE: All doors and sidelites with glass are only available in Smooth or Woodgrain Textured Steel. Woodgrain Textured Steel is NOT available in 8' doors and sidelites. Direct-Set sidelites can be used with all door types.



460TUL, 160TUL (Vineyard)



HARMONY

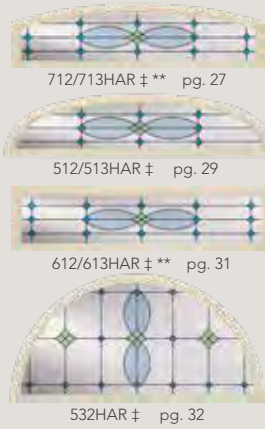

8' Harmony

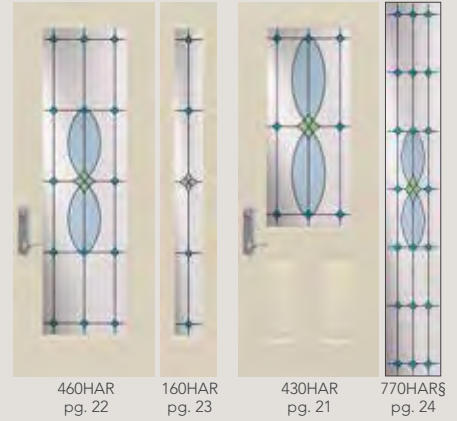

AZTEC

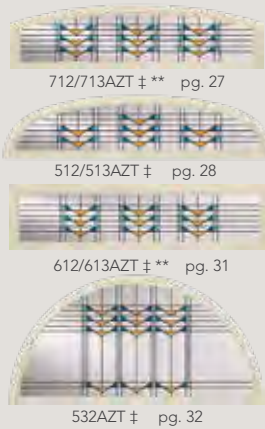
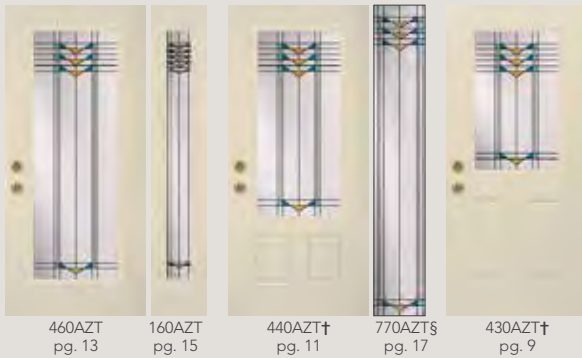

8' Aztec

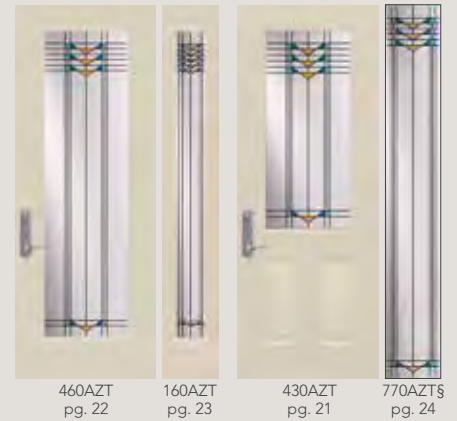

HAVEN



8' Haven



** Requires an additional 4-week lead time

† For additional door panel styles see pg. 22 (for Legacy™)

§ Also available in 10" width. See Price List for design pattern

‡ All transoms must be installed in a separate opening or use approved engineering mulls

NOTE: All doors and sidelites with glass are only available in Smooth or Woodgrain Textured Steel.

Woodgrain Textured Steel is NOT available in 8' doors and sidelites.

Direct-Set sidelites can be used with all door types.

BLOSSOMS



8' Blossoms

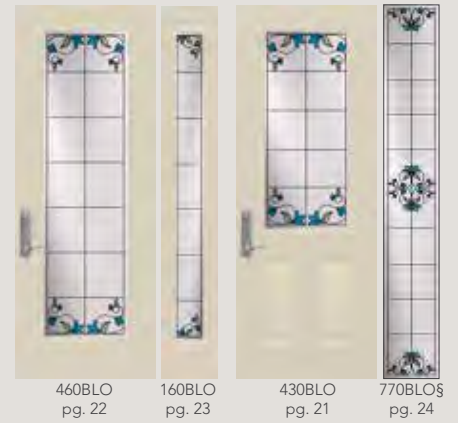

CAMBRIA



8' Cambria



WESTIN

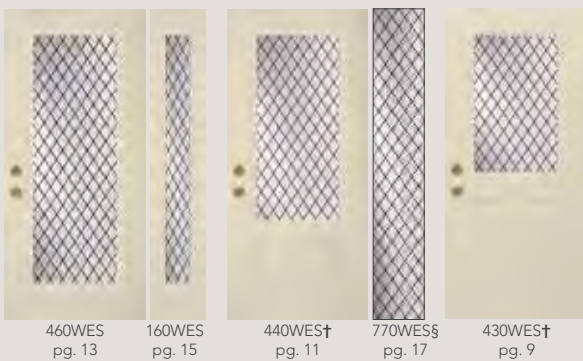

8' Westin

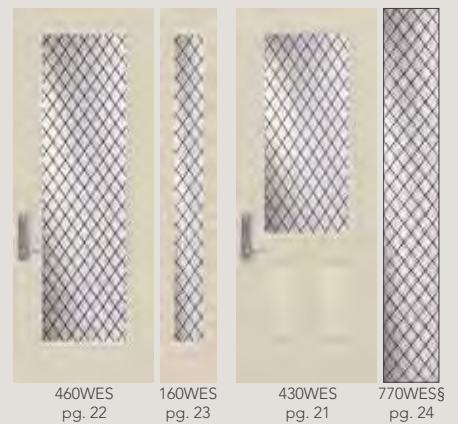

** Requires an additional 4-week lead time
 † For additional door panel styles see pg. 22 (for Legacy™)
 § Also available in 10" width. See Price List for design pattern

‡ All transoms must be installed in a separate opening or use approved engineering mulls
NOTE: All doors and sidelites with glass are only available in Smooth or Woodgrain Textured Steel. Woodgrain Textured Steel is NOT available in 8' doors and sidelites. Direct-Set sidelites can be used with all door types.



460DC-IGT (Brass Pencil Grids)

FRENCH DOORS

custom size DC-IGT ‡** pg. 31

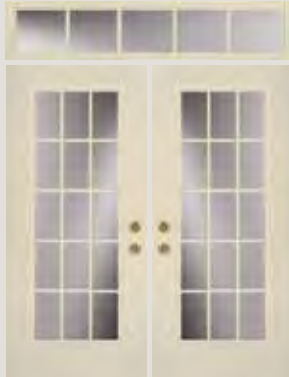

460DC-IGT
pg. 13

460DC-IGT
pg. 13

DESIGNER™ PATIO DOORS

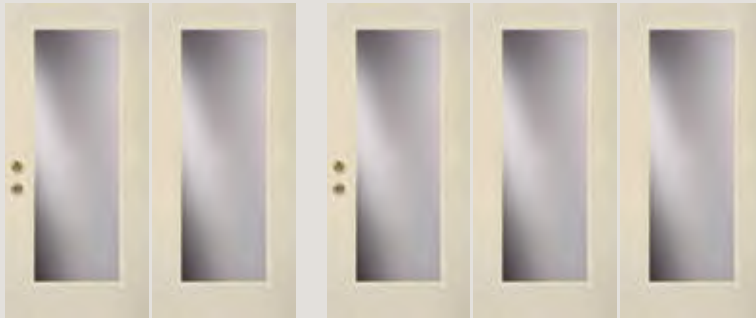

460DC
pg. 26

460DC
pg. 26

460DC
pg. 26

460DC
pg. 26

460DC
pg. 26

VINYL SLIDING PATIO DOORS



only available in 2-lite configuration
pg. 75

** Requires an additional 4-week lead time

‡ All transoms must be installed in a separate opening or use approved engineering mulls
NOTE: All doors and sidelites with glass are only available in Smooth or Woodgrain Textured Steel. Woodgrain Textured Steel is NOT available in 8' doors and sidelites. Direct-Set sidelites can be used with all door types.

— WE SERVE, BY CARING FOR —
DETAILS
IN WAYS OTHERS WON'T

At ProVia, we care about our customers as much as we do the products and services we meticulously provide. We combine old-world craftsmanship with state-of-the-art technology to deliver personalized care with every order. We invite you to experience ProVia's full line of products crafted The Professional Way - which includes the industry's best in doors, windows, siding and stone.

Browse our full line of products at
provia.com

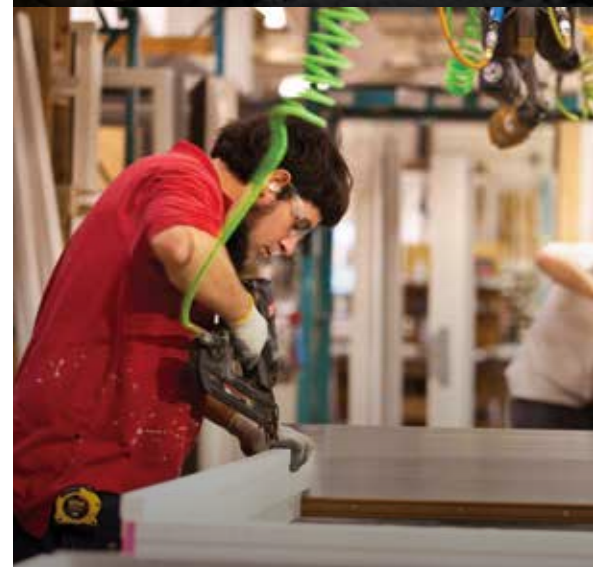



WINDOWS

SIDING

STONE





“To serve, by caring for details in ways others won’t.” It’s not just our mission, but a way of letting our light shine every day at ProVia®. We continually strive to put these words into action by providing unmatched quality and service. The P-icon symbolizes each employee’s commitment to devoting the utmost care, pride and quality into each building product we manufacture...it’s The Professional Way.



At ProVia, we manufacture energy efficient products and exercise corporate environmental stewardship by recycling, reducing pollution emissions and much more. In fact, our company has received repeated awards from the Environmental Protection Agency such as Partner of the Year - Sustained Excellence for Door and Window Manufacturing.



Doors • Windows • Siding • Stone
provia.com

© 2018 ProVia
P-MK-03005-18 10/17 75M

Distributed by:

